

extra[®]
Labelling Systems 



extra4.com

Werkzeuge für die Etiketten-Fertigung
Our tools for production
Nos outils pour la production



Inhaltsverzeichnis

Content

Contenu

3	Schlaufen-Etiketten	Labels with loop	Étiquettes avec lanière
29	Hantel-Etiketten	Dumbbell labels	Étiquettes d'haltères
39	Faden-Etiketten	Labels for threads	Étiquettes à fil
47	Etiketten für Ketten	Labels for chains	Étiquettes pour chaînes
54	Etiketten für Ohringe	Labels for earrings	Étiquettes pour boucles d'oreilles
56	Etiketten für Perl-Schnüre	Labels for pearl-strings	Étiquettes pour perles
57	Form-Kombinationen	Combinations	Combinaison
63	Etiketten für Schreibgeräte	Labels for writing utensils	Étiquettes pour outils pour écrire
64	Card-Etiketten für Zertifikate	Card Labels for certificates	Cartes de certificats
65	Etiketten für Uhren	Labels for watches	Étiquettes pur montres
73	Brillen-Etiketten	Labels for glasses	Étiquettes pour lunettes
79	Haftetiketten	Adhesive labels	Étiquettes adhésives

Schlaufen-Etiketten

Labels with loop

Étiquettes avec lanière



- B** Anzahl Bahnen |
Number of rows |
Nombre de poses
- BB** Bahnbreite |
Width of row |
Largeur de la bande
- T** Etikettenvorschub (Zoll) |
Label feed (inch) |
Avance des étiquettes (pouce)
-  Klassische Etiketten für die manuelle
Beschriftung | Classic labels for
writing on by hand | Étiquettes clas-
siques pour inscription manuelle
- *** Mit durchgestanzten Löchern |
With punched holes |
Avec des trous entièrement percés

SERIE MINI

44 572

B = 1, BB = 88 mm, T = 2/6"



34 572R

B = 1, BB = 88 mm



44 653

B = 1, BB = 88 mm, T = 2/6"

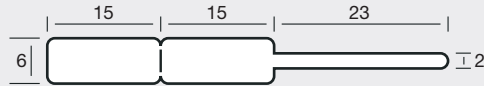

44 745

B = 1, BB = 88 mm, T = 3/6"



34 745R

B = 1, BB = 65 mm

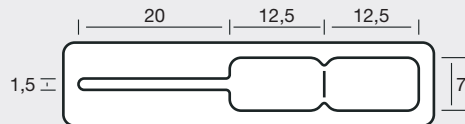

44 753

B = 1, BB = 88 mm, T = 3/6"



34 755IR

B = 1, BB = 70 mm

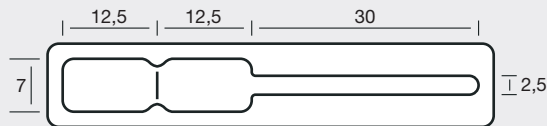

34 755/2R

B = 1, BB = 80 mm

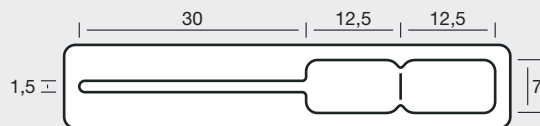

34 760IR

B = 1, BB = 80 mm

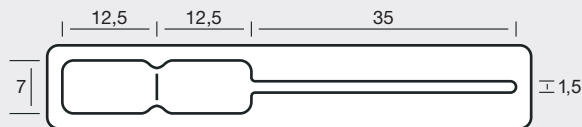

34 761/1IR

B = 1, BB = 90 mm

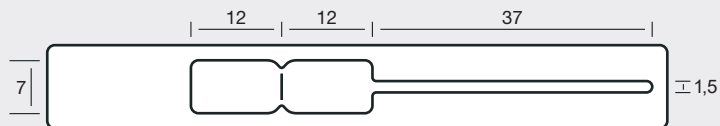

SERIE SMALL

44 859

B = 1, BB = 88 mm, T = 3/6"

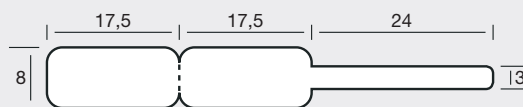

34 865IR

B = 1, BB = 80 mm

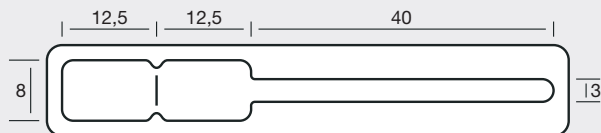

44 868

B = 1, BB = 88 mm, T = 3/6"

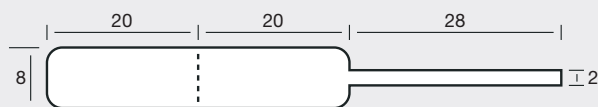

44 868/1

B = 1, BB = 88 mm, T = 3/6"



34 869IR

B = 1, BB = max. 110 mm

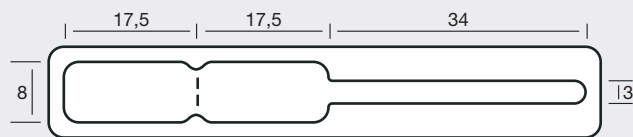

44 870/3

B = 1, BB = 80 mm, T = 3/6"

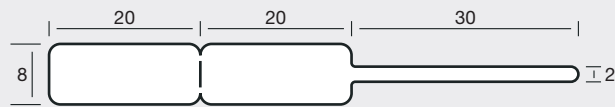

34 870IR

B = 1, BB = 85 mm

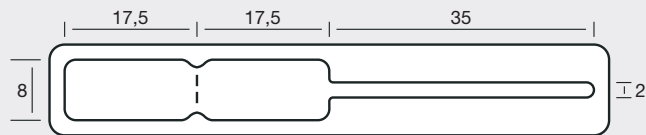

34 875IR

B = 1, BB = 110 mm

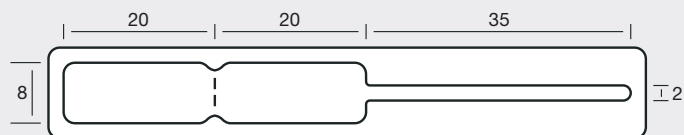

34 880/1

B = 1, BB = 83 mm



34 880IR

B = 1, BB = 110 mm

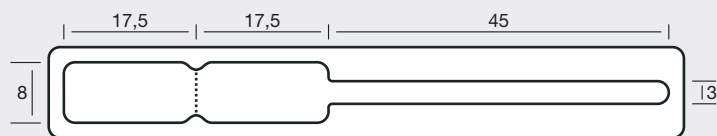

34 885

B = 1, BB = 110 mm

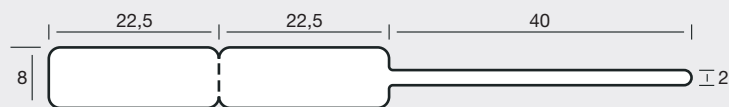

34 886

B = 1, BB = 90 mm

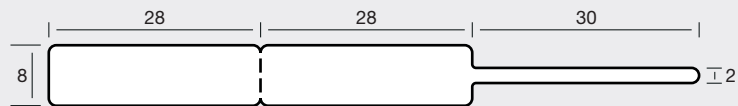

34 956

B = 1, BB = 60 mm



44 959

B = 1, BB = 88 mm, T = 3/6"



34 964IR

B = 1, BB = 90 mm

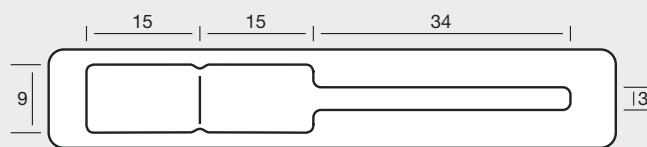

34 974

B = 1, BB = 110 mm



44 1052/5

B = 1, BB = 88 mm, T = 3/6"

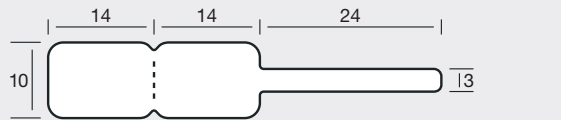

44 1062

B = 1, BB = 88 mm, T = 3/6"

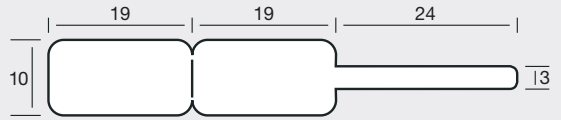

44 1064

B = 1, BB = 88 mm, T = 3/6"

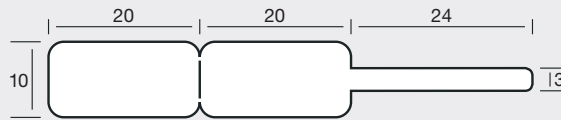

44 1064/1

B = 1, BB = 88 mm, T = 3/6"

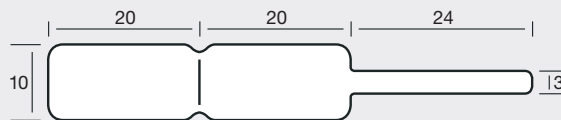

44 1064/3

B = 1, BB = 90 mm, T = 3/6"

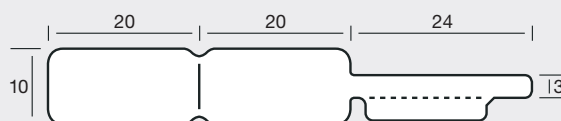

44 1064/7

B = 1, BB = 88 mm, T = 3/6"

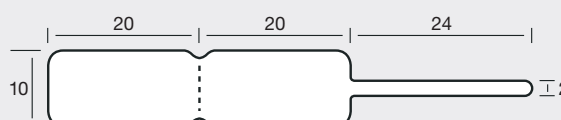

44 1065

B = 1, BB = 88 mm, T = 4/6"



34 1069

B = 1, BB = max. 88 mm

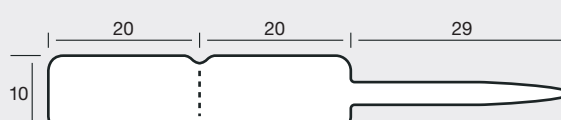

34 1070IR

B = 1, BB = 90 mm, T = 4/6"

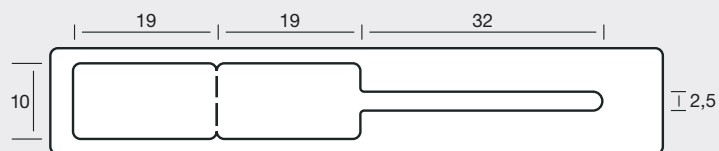

44 1072

B = 1, BB = 88 mm, T = 3/6"

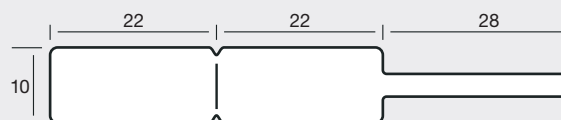

44 1072/7

B = 1, BB = 88 mm, T = 4/6"

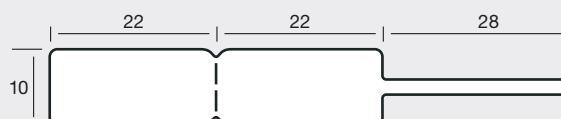

44 1073

B = 1, BB = 88 mm, T = 3/6"

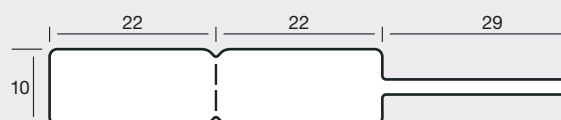

34 1074

B = 1, BB = 88 mm

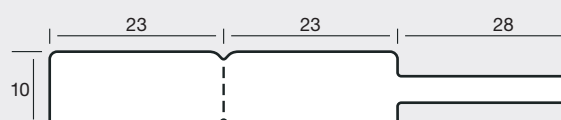

44 1074

B = 1, BB = 88 mm, T = 3/6"

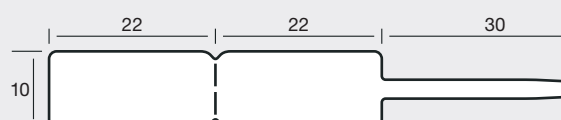

44 1075

B = 1, BB = 90 mm, T = 3/6"

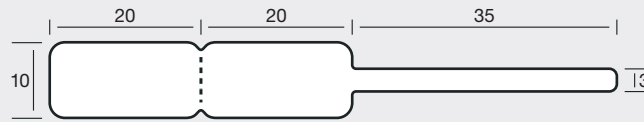

44 1080/1

B = 1, BB = 110 mm, T = 3/6"

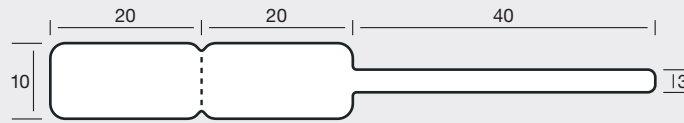

44 1080/2

B = 1, BB = 90 mm, T = 3/6"



44 1082

B = 1, BB = 110 mm, T = 3/6"

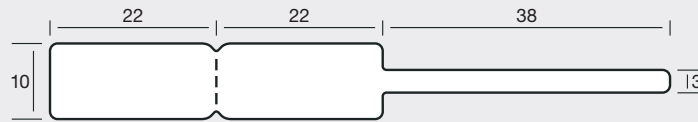

44 1082/2

B = 1, BB = 110 mm, T = 3/6"

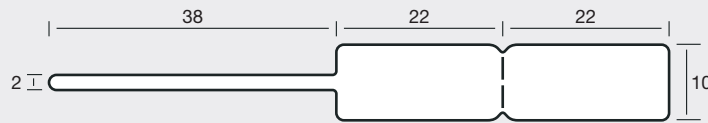

34 1086

B = 1, BB = 110 mm

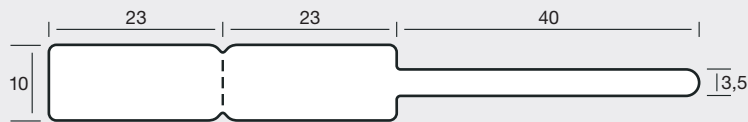

34 1087

B = 1, BB = 120 mm

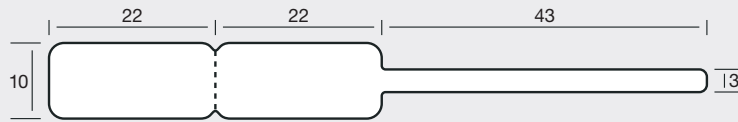

34 1090

B = 1, BB = 110 mm

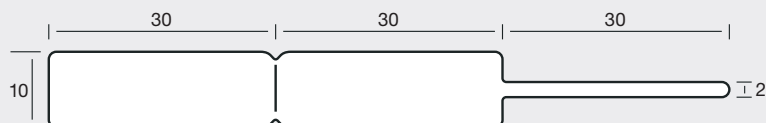

34 1094

B = 1, BB = 110 mm

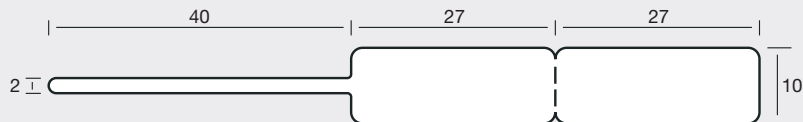

44 1096

B = 1, BB = 110 mm, T = 3/6"



44 1096/1

B = 1, BB = 120 mm, T = 3/6"

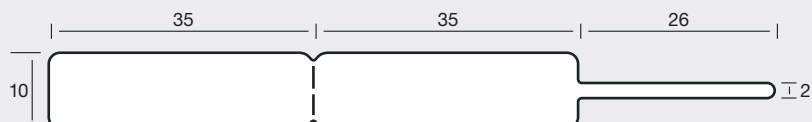

34 1097

B = 1, BB = 120 mm

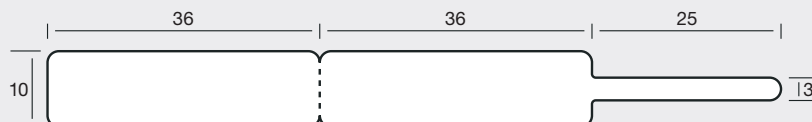

44 10104/1

B = 1, BB = 110 mm, T = 3/6"



44 1151

B = 1, BB = 88 mm, T = 3/6"

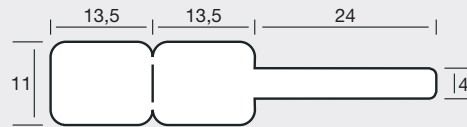

44 1153

B = 1, BB = 88 mm, T = 3/6"

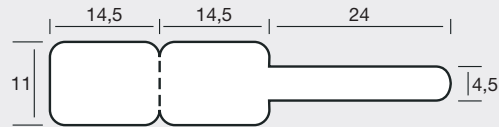

44 1154/1

B = 1, BB = 88 mm, T = 3/6"

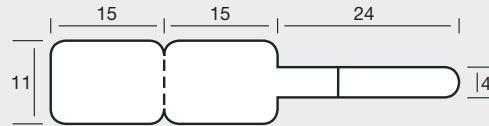

44 1156/1

B = 1, BB = 80 mm, T = 3/6"

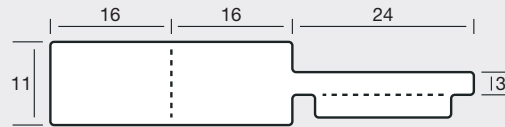

34 1156/1

B = 1, BB = 88 mm

44 1156/2

B = 1, BB = 88 mm, T = 3/6"

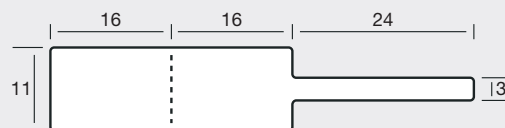

44 1161

B = 1, BB = 88 mm, T = 3/6"

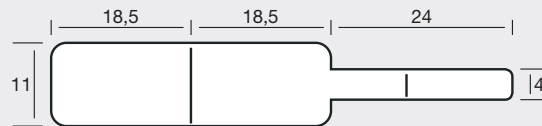

44 1161/1

B = 1, BB = 88 mm, T = 3/6"

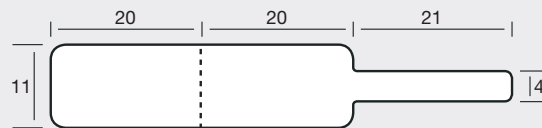

44 1164

B = 1, BB = 88 mm, T = 3/6"



34 1166

B = 1, BB = max. 100 mm

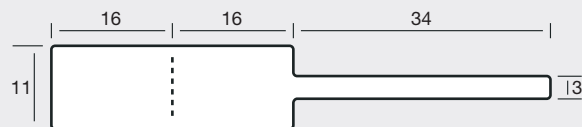

44 1166

B = 1, BB = 85 mm, T = 4/6"

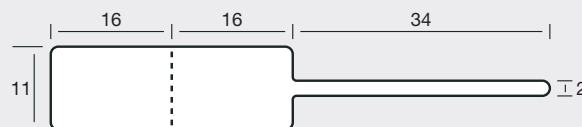

44 1170/1

B = 1, BB = 88 mm, T = 3/6"

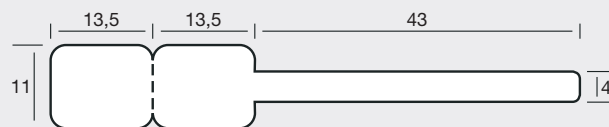

44 1170/2

B = 1, BB = 110 mm, T = 3/6"



34 1172

B = 1, BB = max. 88 mm

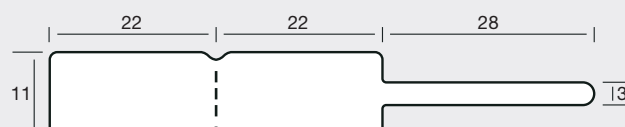

34 1181

B = 1, BB = max. 110 mm

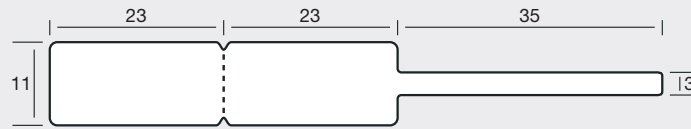

44 1187/1

B = 1, BB = max. 110 mm, T = 5/8"

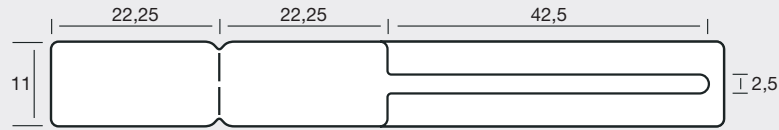

34 1185/3

B = 1, BB = 110 mm

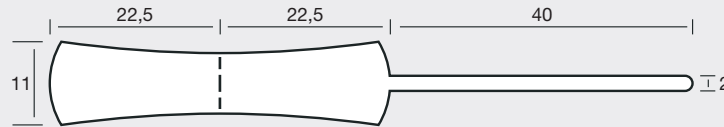

34 1185/2

B = 1, BB = 110 mm

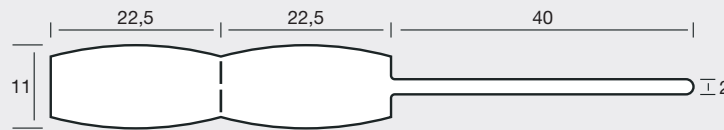

34 1187

B = 1, BB = 110 mm



44 1187

B = 1, BB = 110 mm, T = 3/6"

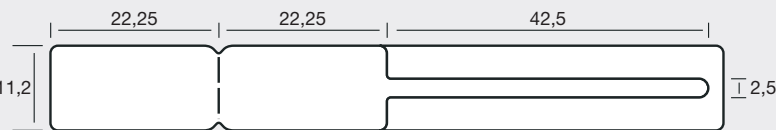

44 1187/1

B = 1, BB = 120 mm, T = 5/8"
 funktionsgleich mit Etikett
 TT303 oder TT306 von arch.
 crown |
 same function as label
 TT303 or TT306 from arch.
 crown |
 même fonction avec
 l'étiquette TT303 ou TT306
 de arch.crown

34 1189

B = 1, BB = 120 mm
 funktionsgleich mit Etikett
 T-250 von ZETAGS |
 same function as label
 T-250 from ZETAGS |
 même fonction avec
 l'étiquette T-250 de ZETAGS

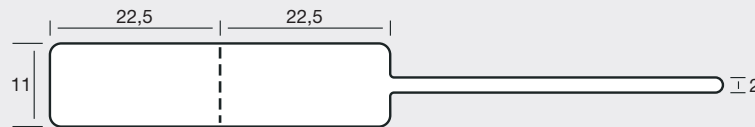

34 1193

B = 1, BB = 110 mm

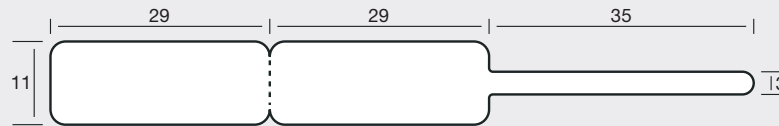

34 1194

B = 1, BB = 100 mm



34 1194/1

B = 1, BB = 120 mm

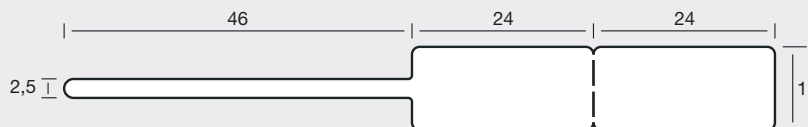

34 1260

B = 1, BB = max. 88 mm

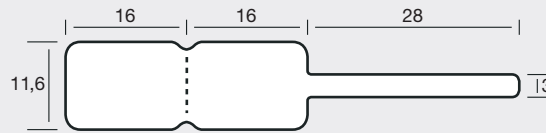

34 1266

B = 1, BB = 69 mm
Kompatibel mit
UJS-Warenwirtschaft

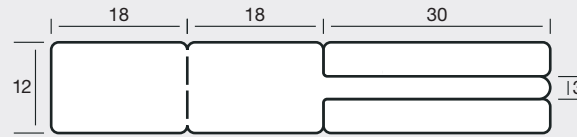

44 1272

B = 1, BB = 100 mm, T = 5/6"

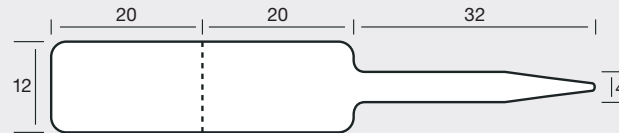

34 1280

B = 1, BB = 110 mm

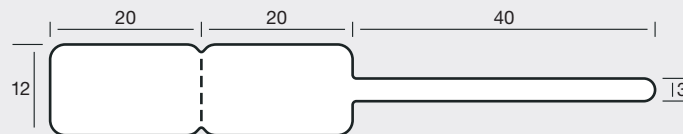

34 1284

B = 1, BB = 110 mm

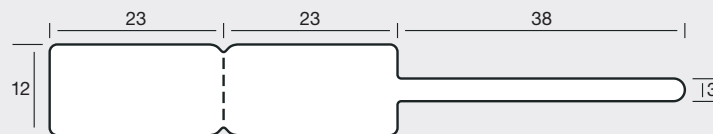

34 1284/2

B = 1, BB = 100 mm

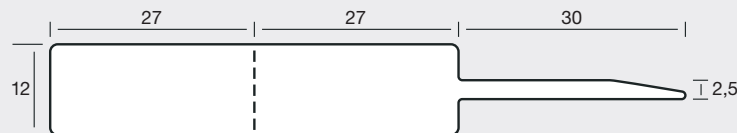

34 1285

B = 1, BB = 88 mm

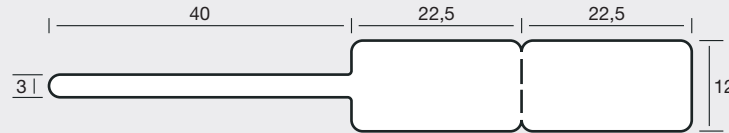

34 1285/2

B = 1, BB = 110 mm

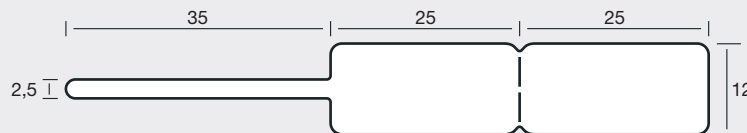

34 1287

B = 1, BB = 110 mm

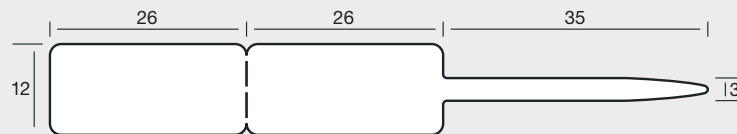

34 1289

B = 1, BB = 110 mm

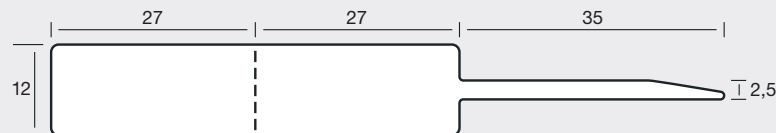

34 1290

B = 1, BB = 100 mm

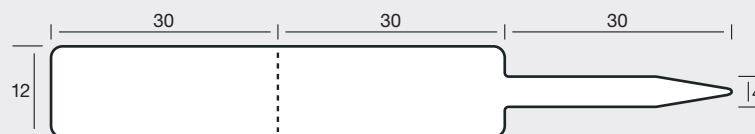

34 1290/3

B = 1, BB = 120 mm

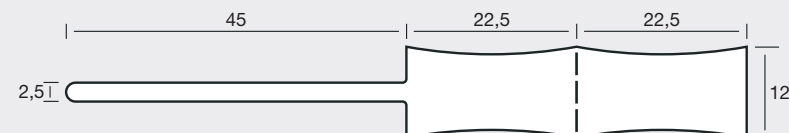

SERIE STANDARD

34 1292

B = 1, BB = 110 mm



44 1292

B = 1, BB = 120 mm, T = 4/6"

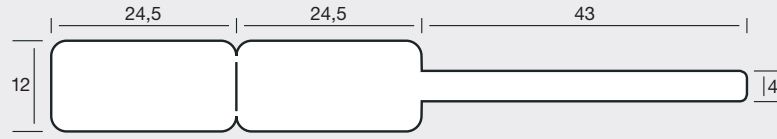

34 12100

B = 1, BB = 108 mm

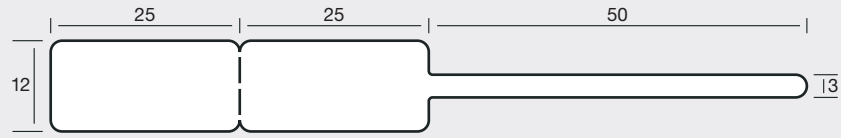

34 12102

B = 1, BB = 110 mm

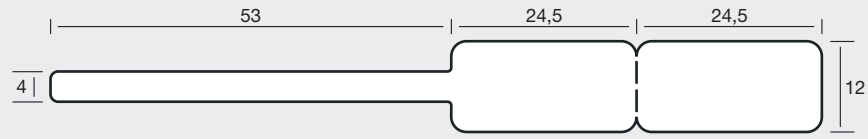

34 12105

B = 1, BB = 120 mm

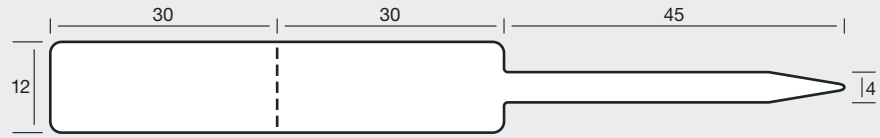

SERIE BIG

34 1360

B = 1, BB = max. 88 mm

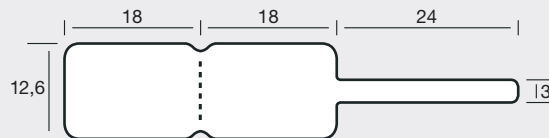

34 1364

B = 1, BB = 85 mm

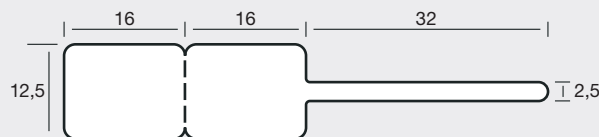

34 1375

B = 1, BB = 90 mm

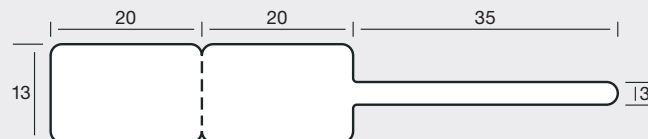

34 1376

B = 1, BB = 90 mm

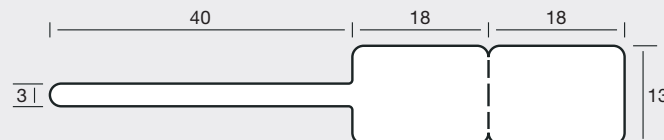

34 1384

B = 1, BB = 88 mm

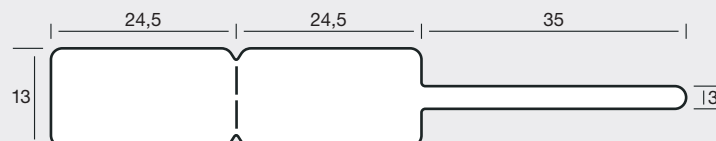

44 1386

B = 1, BB = 120 mm, T = 4/6"

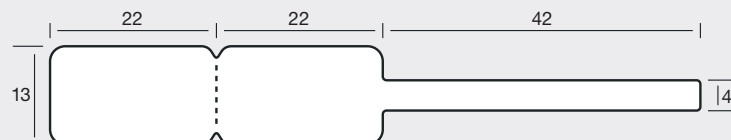

44 1390

B = 1, BB = 130mm, T = 4/6"

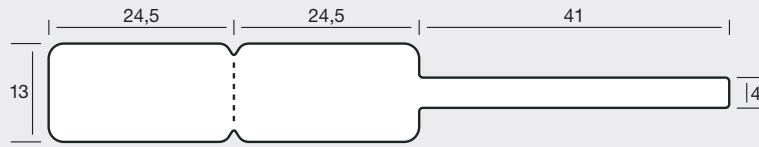

44 1390/3

B = 1, BB = 100 mm, T = 4/6"

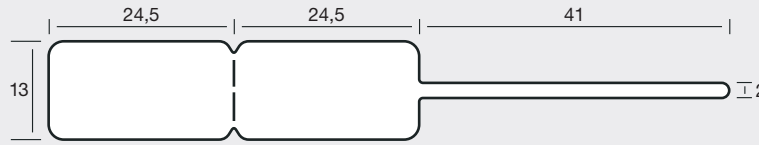

34 1390/1

B = 1, BB = 120 mm

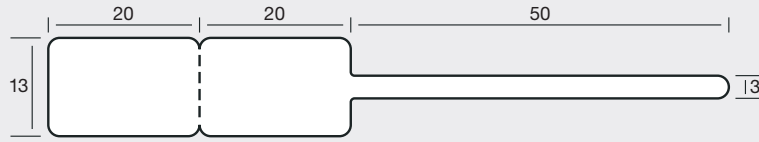

34 1390IR

B = 1, BB = 120 mm

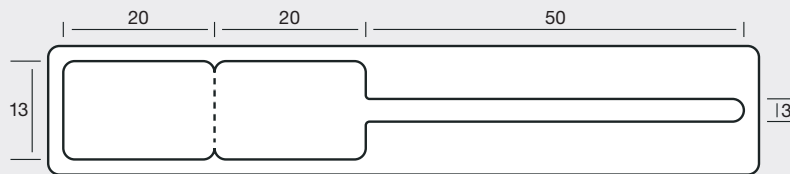

34 1396

B = 1, BB = 110 mm

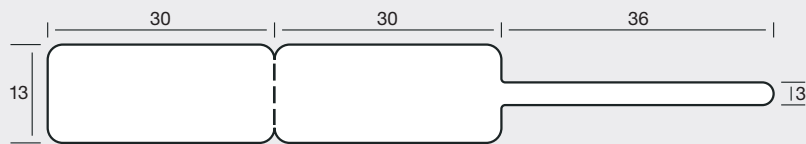

34 1396L*

B = 1, BB = 110 mm

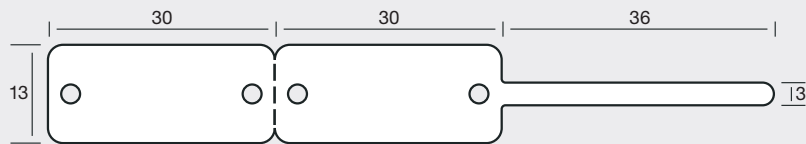

44 13100

B = 1, BB = 130 mm, T = 4/6"

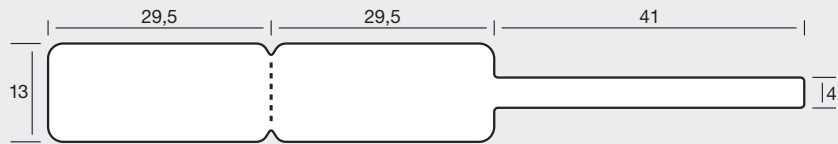

34 13100/1

B = 1, BB = 110 mm

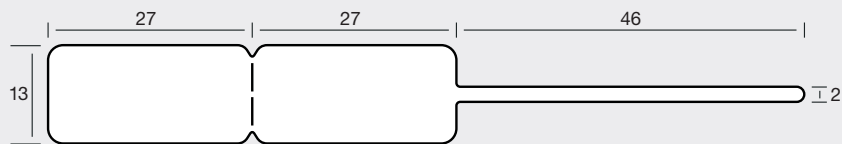

34 13103

B = 1, BB = 130 mm

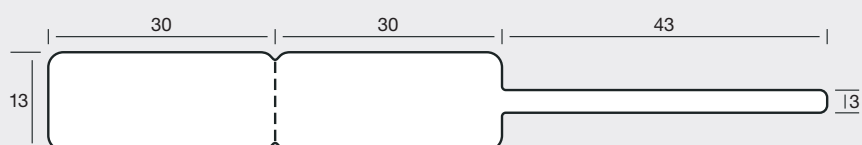

34 13104

B = 1, BB = 130 mm

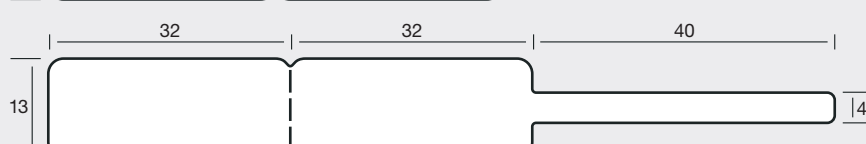

34 1473

B = 1, BB = 88 mm

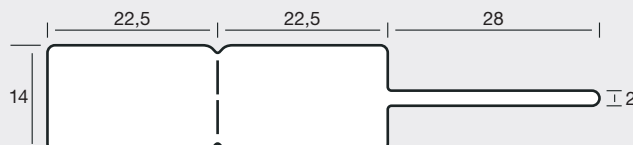

44 1473

B = 1, BB = 100 mm, T = 4/6"

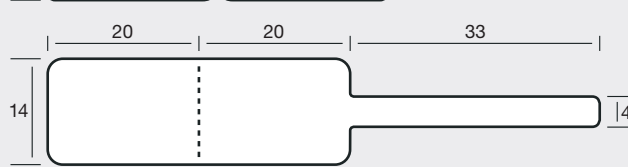

SERIE BIG

34 1572

B = 1, BB = 88 mm

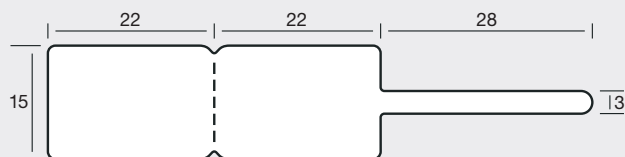

34 1572/1

B = 1, BB = 90 mm

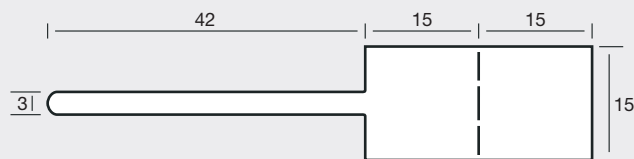

34 1591

B = 1, BB = 110 mm

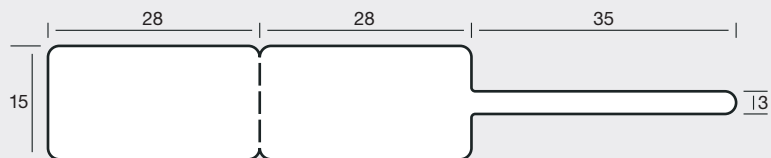

34 15105

B = 1, BB = 110 mm

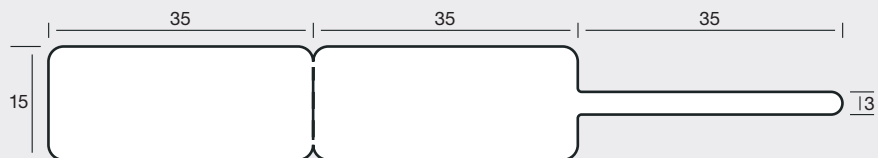

44 1690

B = 1, BB = 130 mm, T = 7/8"

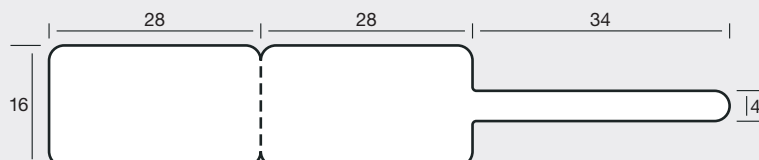

34 1993

B = 1, BB = 110 mm, T = 13/15"



44 19120

B = 1, BB = 140 mm, T = 6/6"

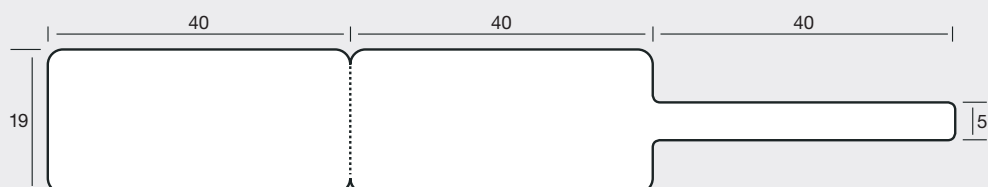

SERIE ROUND

34 1568R

B = 1, BB = 90 mm

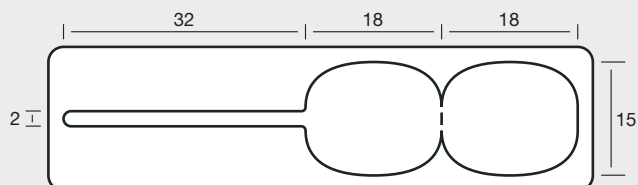

34 1657R

B = 1, BB = 70 mm

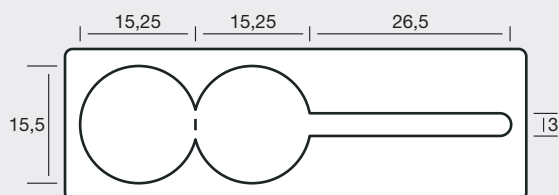

44 1758

B = 1, BB = 88 mm, T = 5/6"

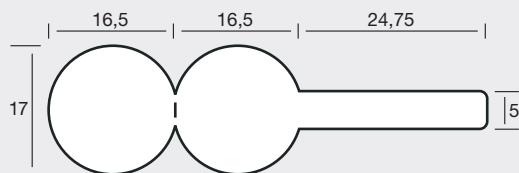

44 1758/1

B = 1, BB = 88 mm, T = 6/8"

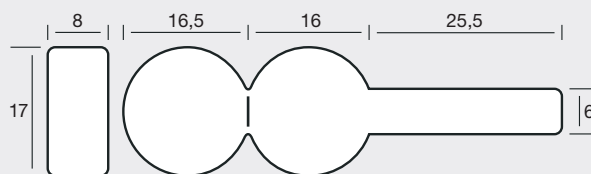

34 1758IR

B = 1, BB = 88 mm

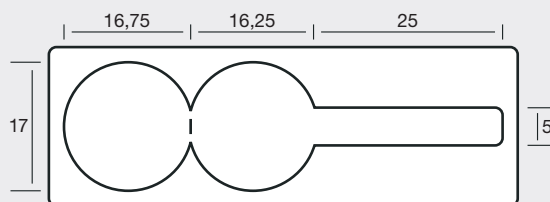

34 1768/2IR

B = 1, BB = 80 mm

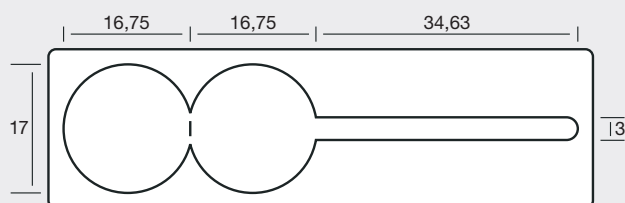

34 1768IR

B = 1, BB = 90 mm

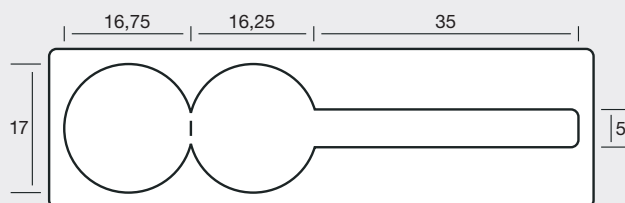

34 3453R

B = 1, BB = 60 mm

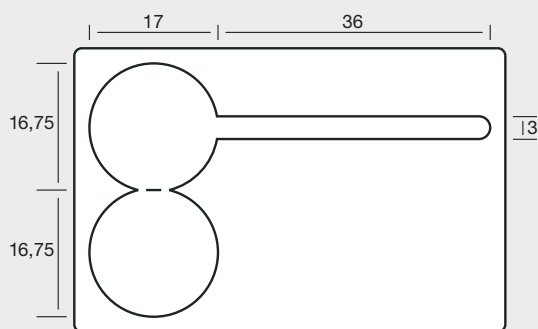

34 1774/1R

B = 1, BB = 110 mm

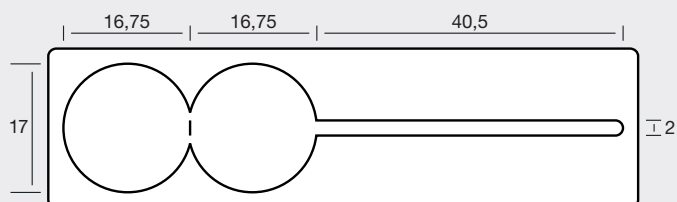

34 1852IR

B = 1, BB = 85 mm

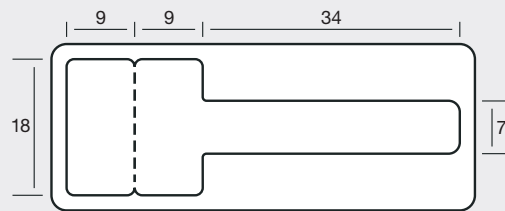

34 1947IR

B = 1, BB = 88 mm

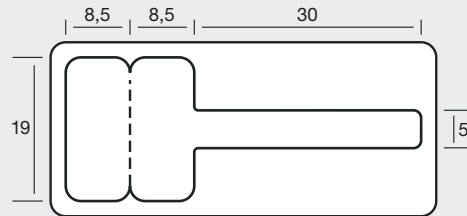

34 2250IR

B = 1, BB = 88 mm

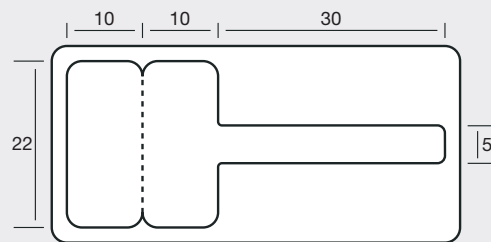

34 2270IR

B = 1, BB = 80 mm

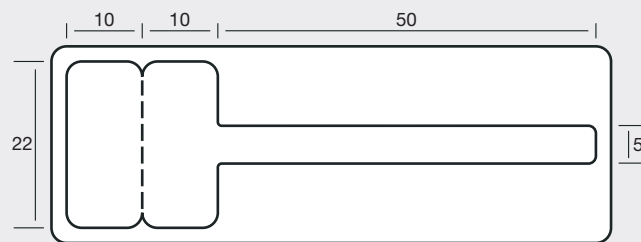

34 3050IR

B = 1, BB = 88 mm

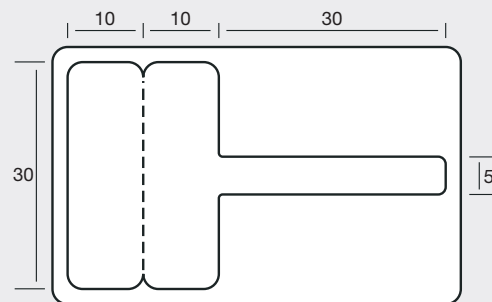

34 5022IR

B = 1, BB = 40 mm

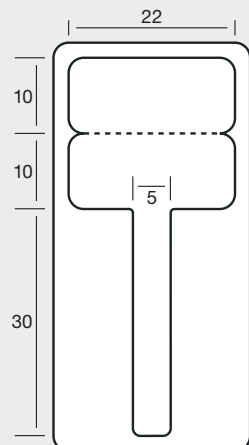

34 1448R

B = 1, BB = 60 mm

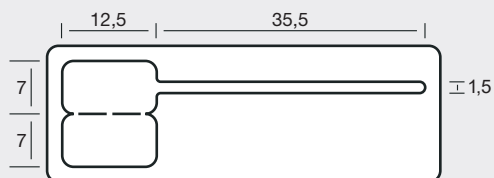

44 1454

B = 1, BB = 88 mm, T = 4/6"

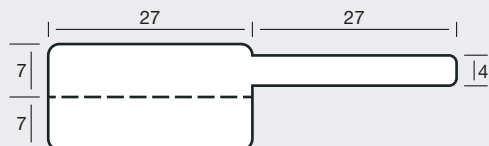

34 1644

B = 1, BB = 88 mm

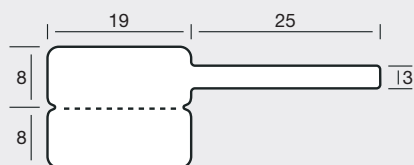

34 1650

B = 1, BB = 88 mm

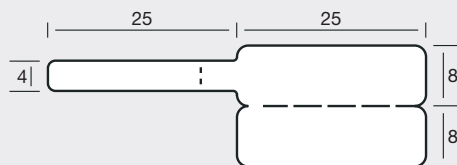

34 1649IR

B = 1, BB = 70 mm

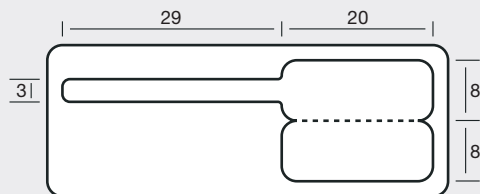

34 1652

B = 1, BB = 90 mm

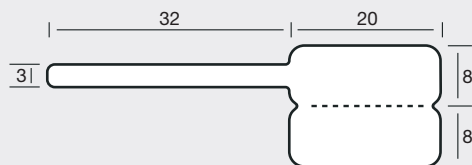

34 1653R

B = 1, BB = 60 mm

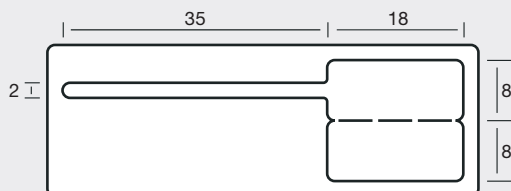

44 1660

B = 1, BB = 88 mm, T = 5/6"

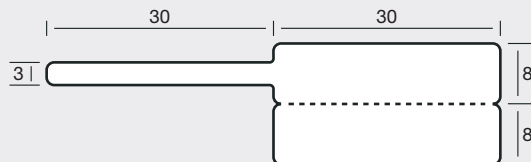

44 1660/1

B = 1, BB = 88 mm, T = 8/10"

34 1682

B = 1, BB = 100 mm

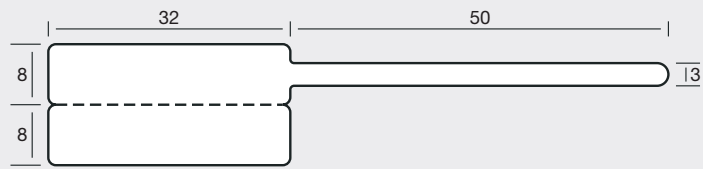

34 1848

B = 1, BB = 90 mm

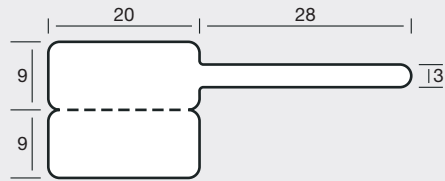

44 1855

B = 1, BB = 88 mm, T = 5/6"

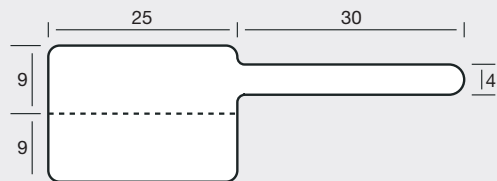

34 1860

B = 1, BB = 70 mm

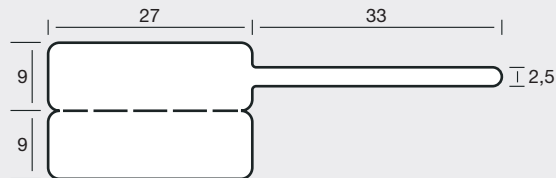

34 2040

B = 1, BB = 130 mm

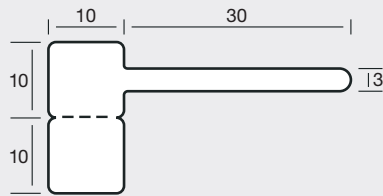

44 2046

B = 1, BB = 88 mm, T = 6/6"

44 2046/2

B = 2, BB = 120 mm, T = 6/6"

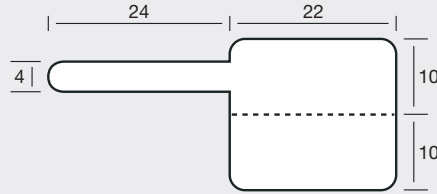

44 2046/5

B = 2, BB = 120 mm, T = 6/6"

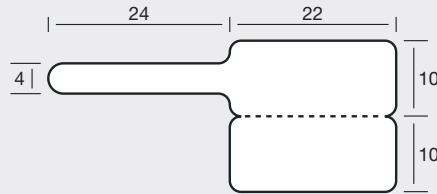

34 2046RSW

B = 2, BB = 130 mm, T = 10/9"

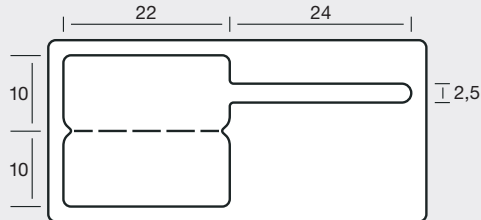

34 2048

B = 1, BB = 130 mm

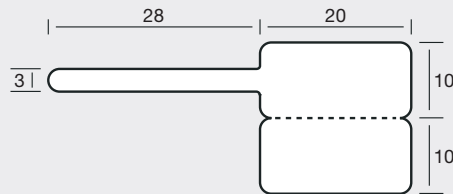

34 2048/1

B = 1, BB = 88 mm

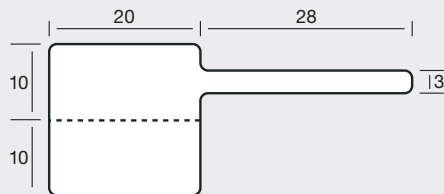

34 2048/2

B = 1, BB = 70 mm

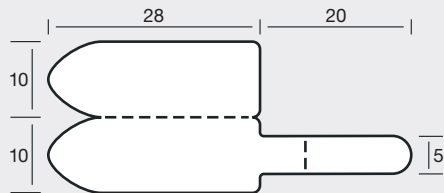

34 2049

B = 1, BB = 88 mm

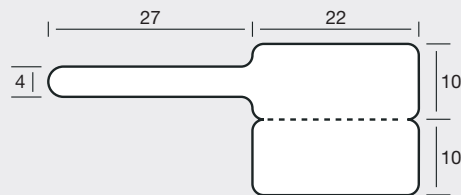

34 2050IR

B = 1, BB = 60 mm

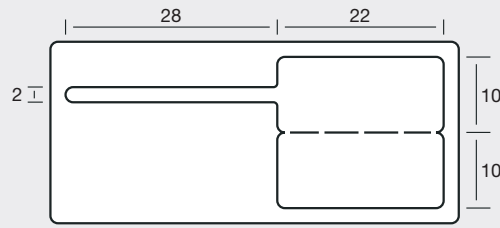

34 2054

B = 1, BB = 90 mm

34 2054/1

B = 1, BB = 130 mm

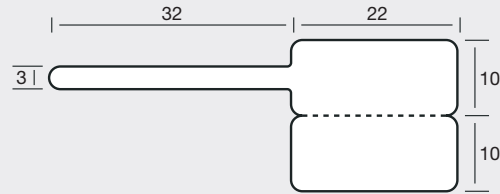

34 2056

B = 1, BB = 90 mm

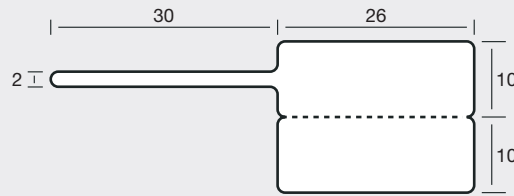

34 2057

B = 1, BB = 100 mm

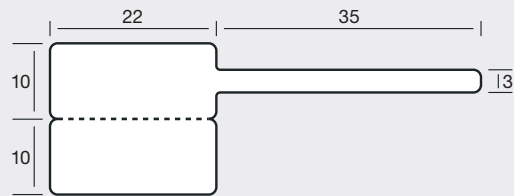

44 2058

B = 1, BB = 88 mm, T = 6/6"

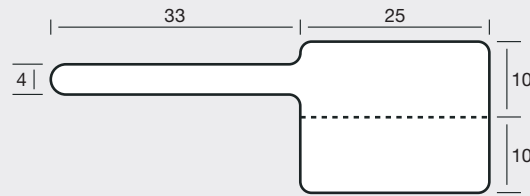

44 2062

B = 1, BB = 100 mm, T = 6/6"

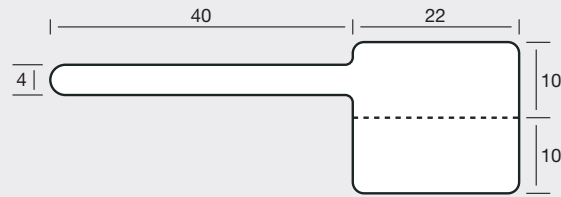

34 2065

B = 1, BB = 70 mm

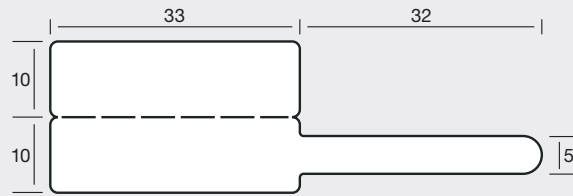

34 2072

B = 1, BB = 100 mm

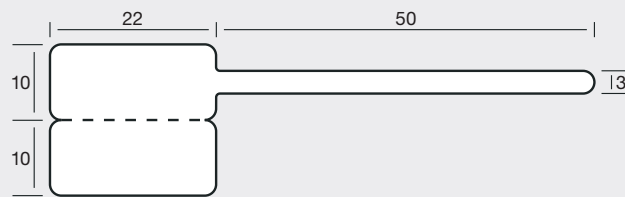

34 2072IR

B = 1, BB = 100 mm

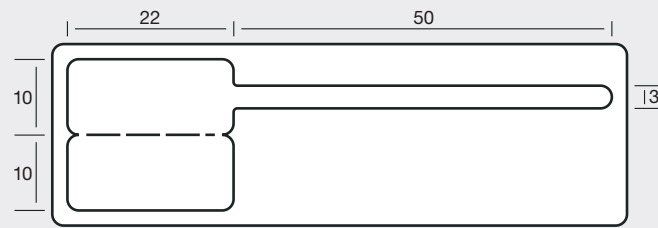

34 2091R

B = 1, BB = 130 mm

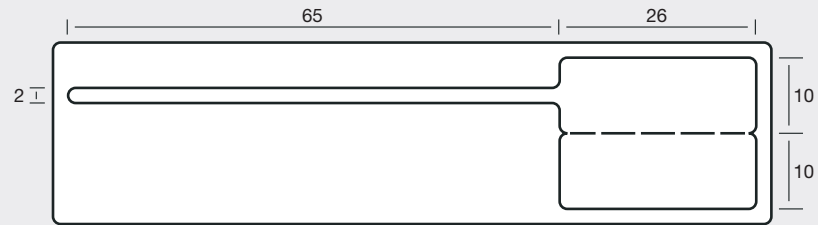

34 2092

B = 1, BB = 100 mm

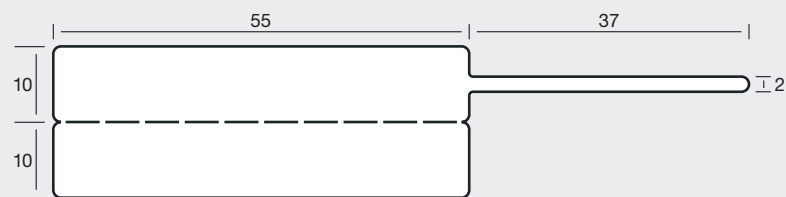

34 2096/1R

B = 1, BB = 110 mm

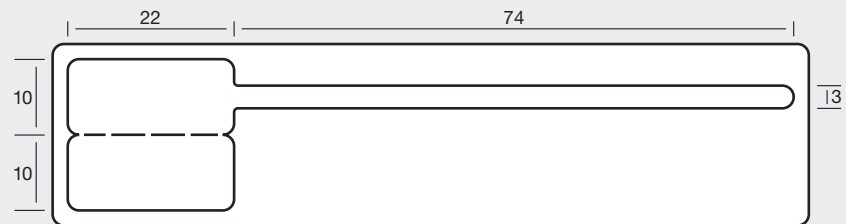

34 2267

B = 1, BB = 100 mm

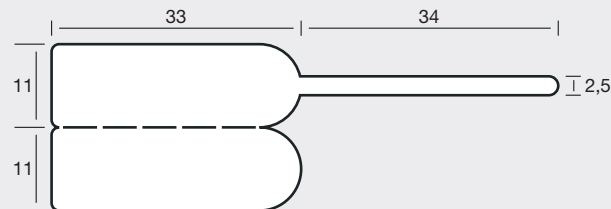

34 2280

B = 1, BB = 90 mm

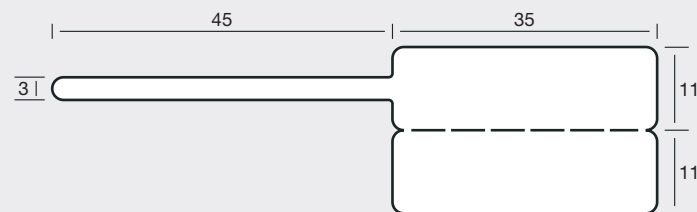

44 2450

B = 2, BB = 130 mm, T = 6/6"

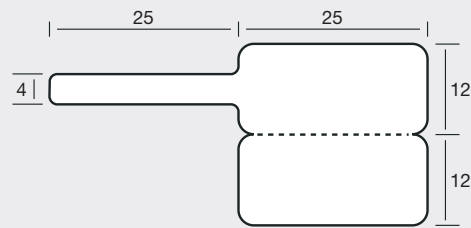

34 2450

B = 2, BB = 130 mm

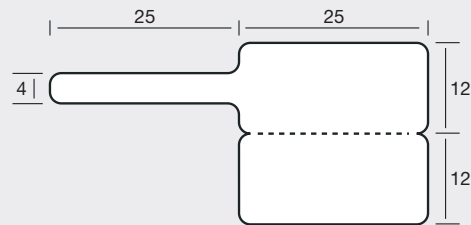

34 2454

B = 1, BB = 88 mm

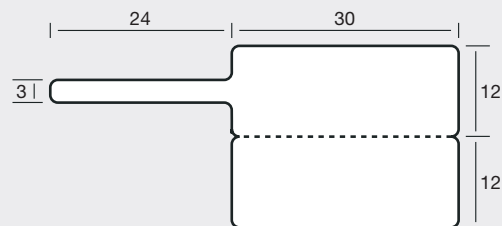

34 2460

B = 1, BB = 80 mm

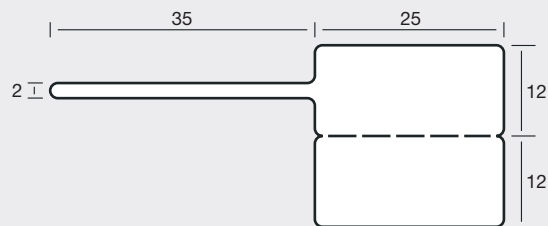

34 2465IR

B = 1, BB = 80 mm

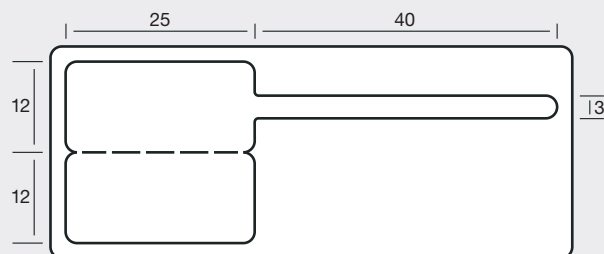

34 2475

B = 1, BB = 100 mm

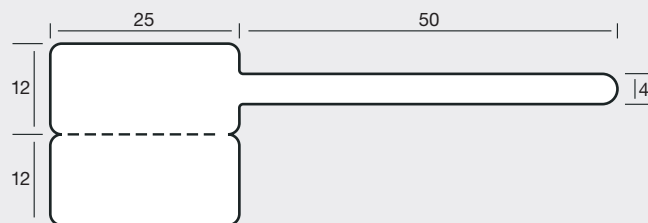

34 2482IR

B = 1, BB = 110 mm,
für Eltron TLP 2742

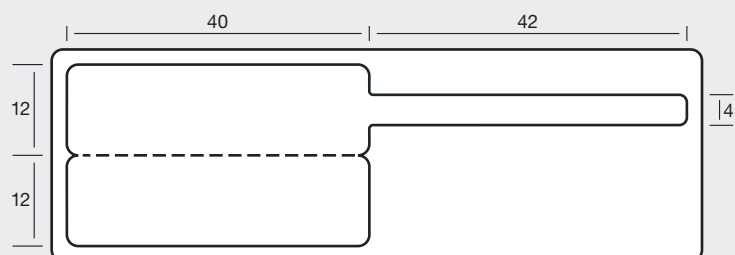

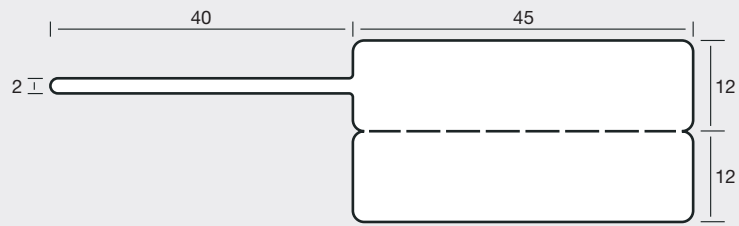

34 2485/1

B = 1, BB = 95 mm

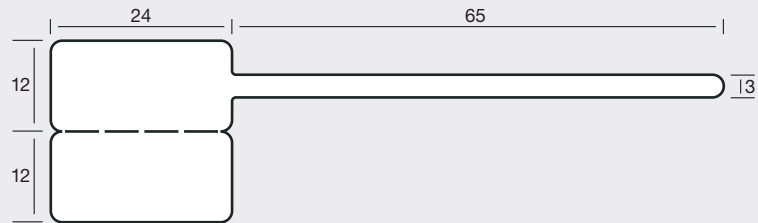

34 2489/1

B = 1, BB = 120 mm

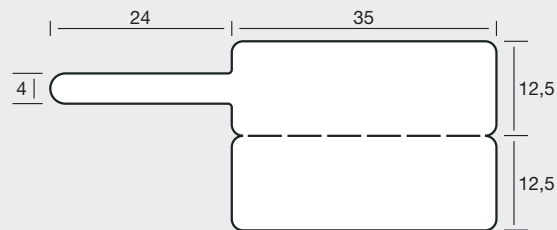

34 2559

B = 1, BB = 88 mm

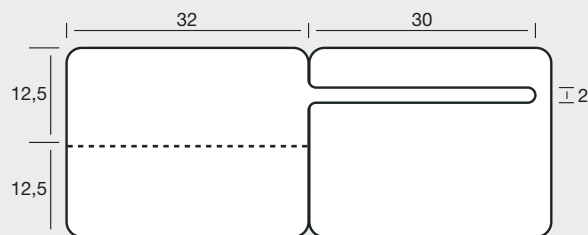

34 2562

B = 1, BB = 110 mm

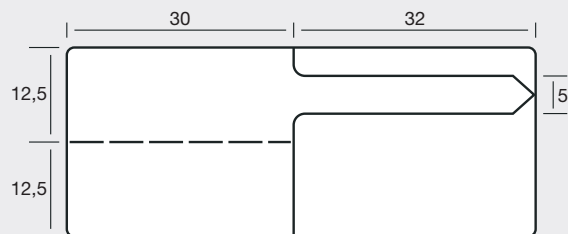

34 2562/1

B = 1, BB = 90 mm

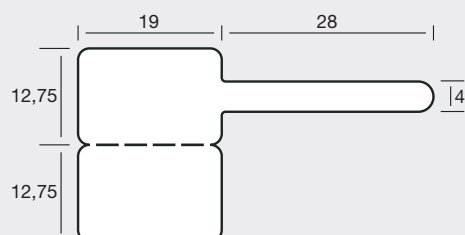

34 2647

B = 2, BB = 130 mm

34 2662

B = 1, BB = 90 mm

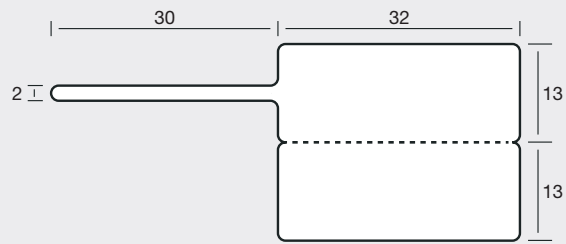

34 2662/1

B = 1, BB = 85 mm

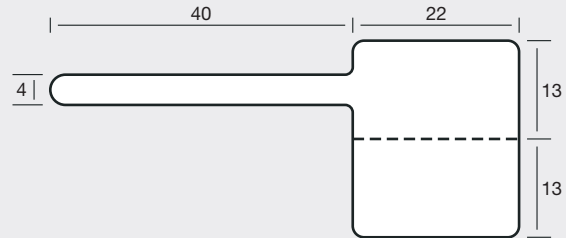

34 2676R

B = 1, BB = 100 mm

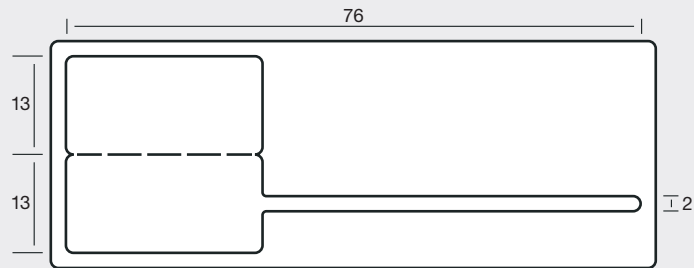

34 2685

B = 1, BB = 100 mm

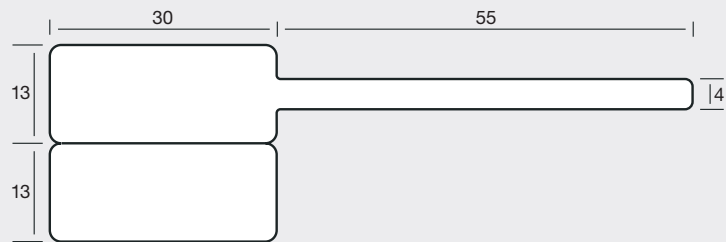

34 26106

B = 1, BB = 114 mm

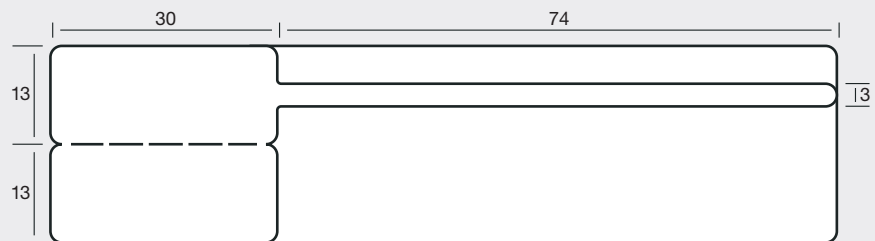

34 3054

B = 1, BB = 80 mm

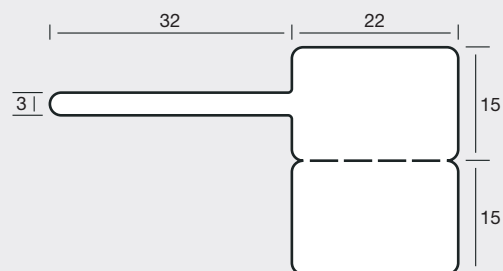

34 3070

B = 1, BB = 90 mm

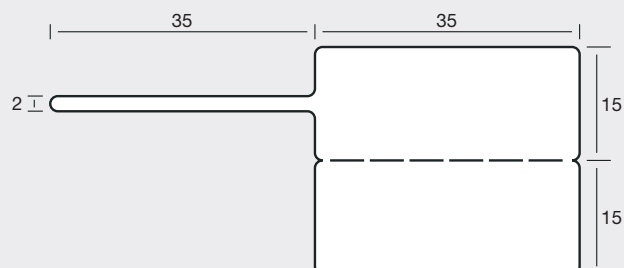

34 3095

B = 1, BB = 110 mm

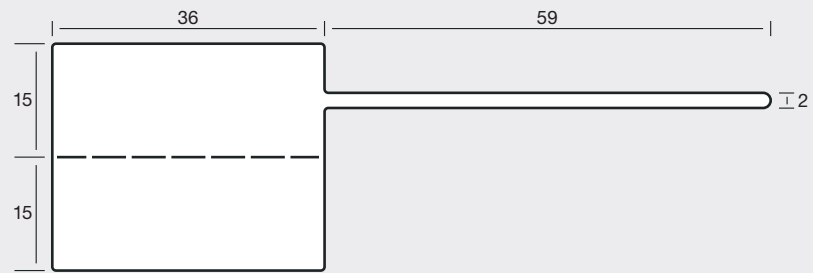

34 30100

B = 1, BB = 110 mm

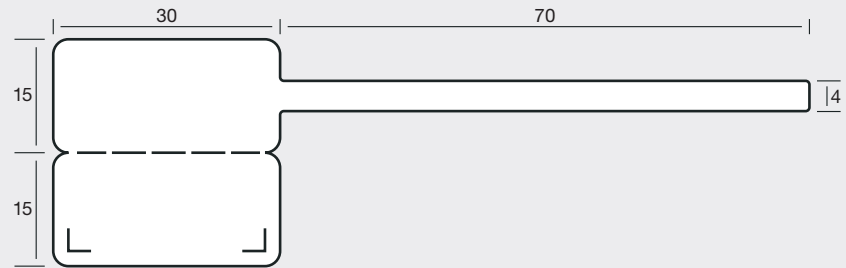

34 3254

B = 1, BB = 60 mm

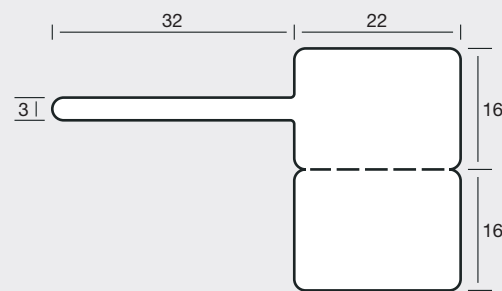

34 3475IR

B = 1, BB = 90 mm

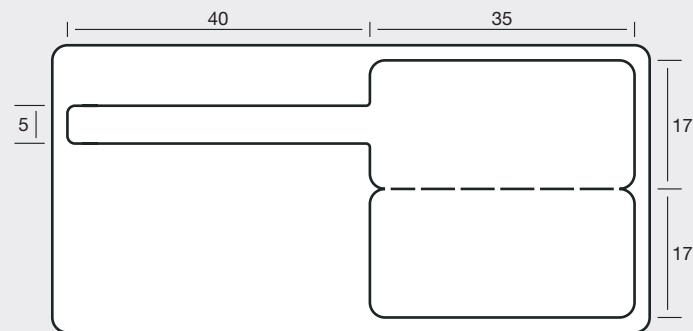

34 3490

B = 1, BB = 120 mm

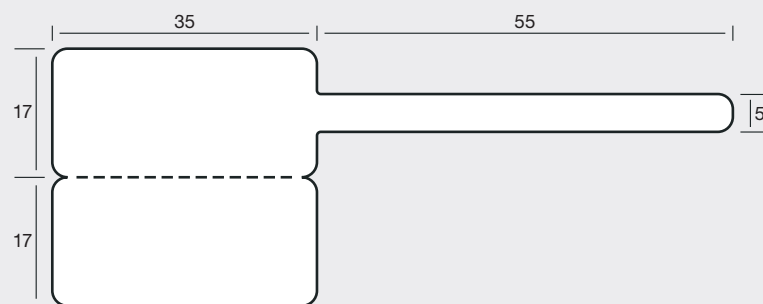

34 3496

B = 1, BB = 120 mm

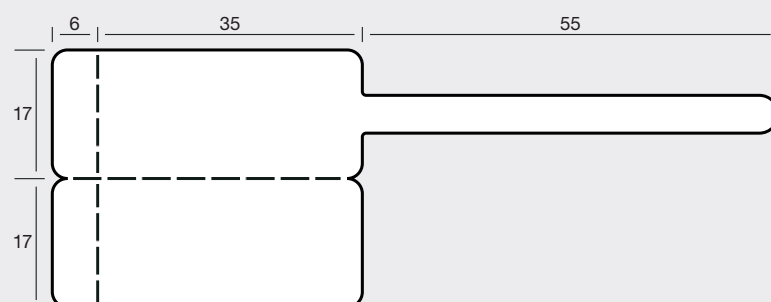

44 2042

B = 2, BB = 110 mm, T = 6/6"

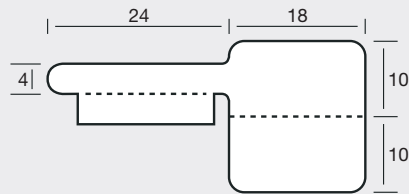

44 2046/1

B = 2, BB = 120 mm, T = 6/6"

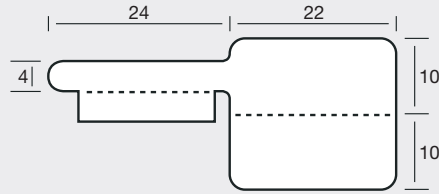

44 2055

B = 2, BB = 130 mm, T = 6/6"

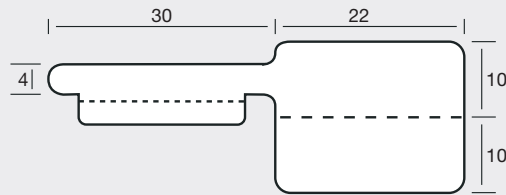

34 2056/1L*

B = 1, BB = 90 mm

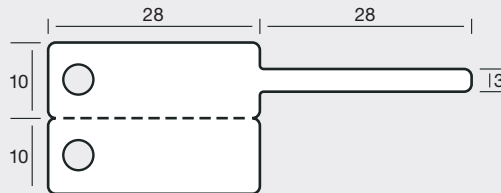

34 2086

B = 1, BB = 110 mm

Mit Abrissfeld für separates Platzieren nach dem Verkauf

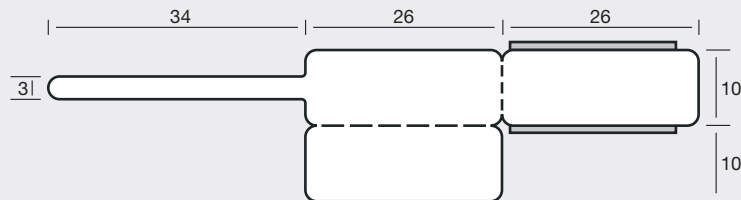

44 10100L*

B = 1, BB = 140 mm, T = 3/6"

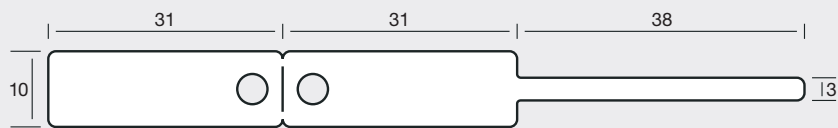

44 10108

B = 1, BB = 130 mm, T = 3/6"

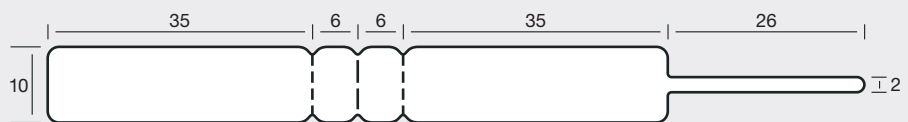

34 1482

B = 1, BB = 90 mm

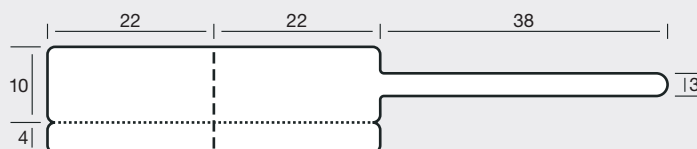

34 1483

B = 1, BB = 90 mm

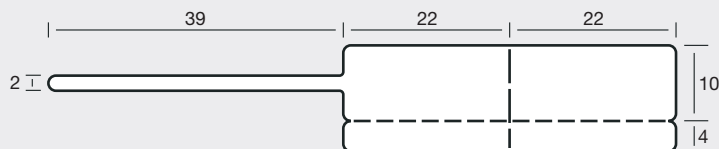

34 2079/1

B = 1, BB = 110 mm

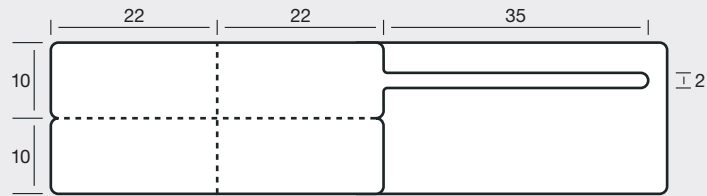

34 2690/1

B = 1, BB = 100 mm

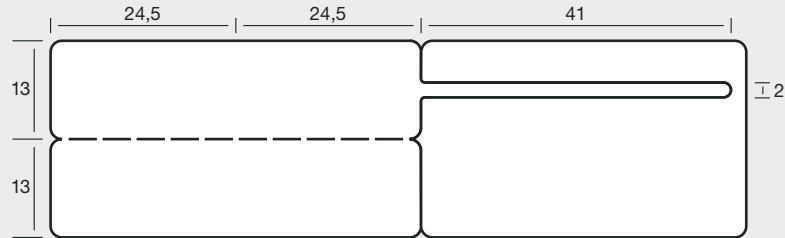

44 894/1

B = 1, BB = 120 mm, T = 3/6"

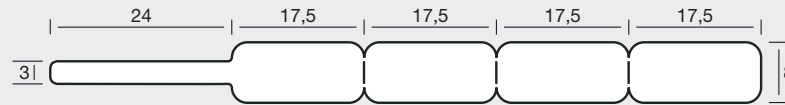

44 894/2

B = 1, BB = 120 mm, T = 3/6"



34 11104

B = 1, BB = 120 mm



34 11118

B = 1, BB = 140 mm

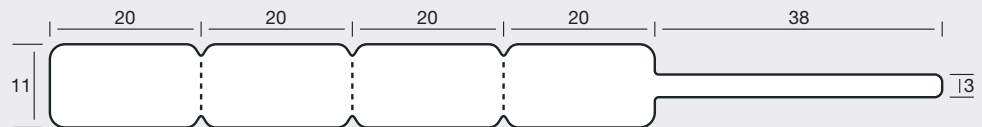

34 14104

B = 1, BB = 120 mm

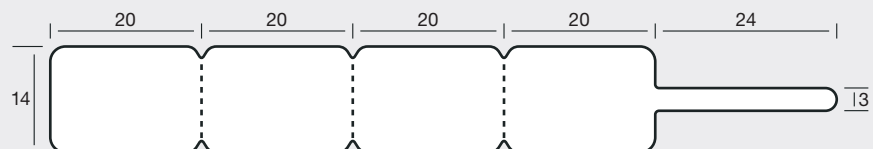

34 17101R

B = 1, BB = 130 mm

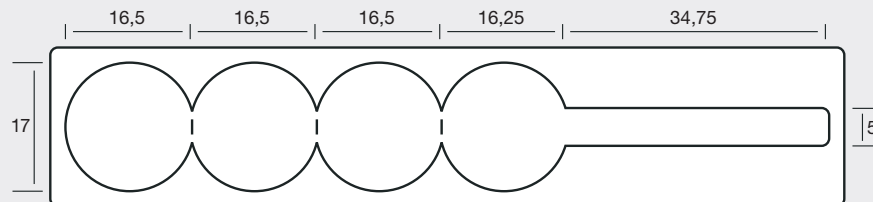

34 17102

B = 1, BB = 120 mm

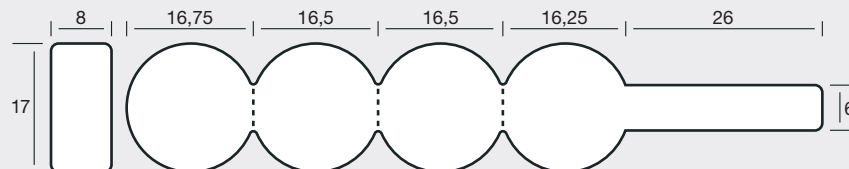

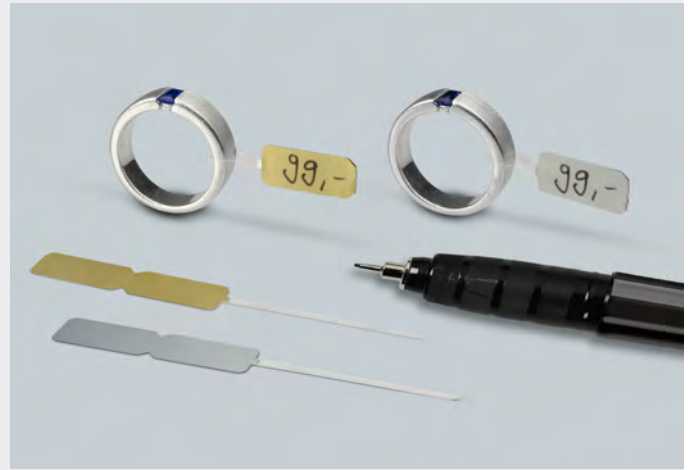

44 1056/PE 

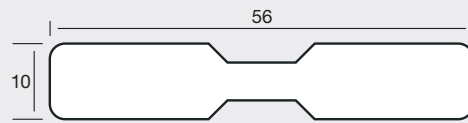

44 870 XHB 

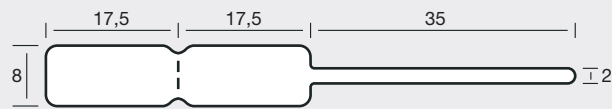

44 1072 XHB 

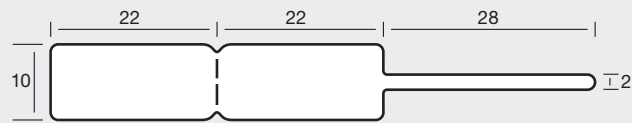

44 1082 XHB 

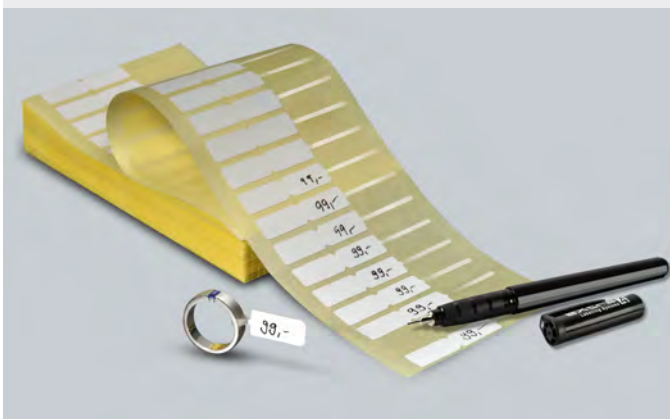
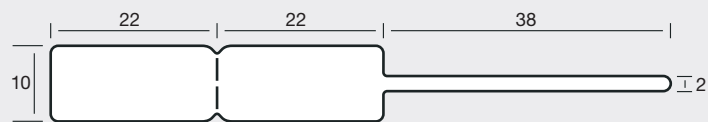



Im Polybeutel in Lagen gefaltet |
in plastic bag, folded in layers |
dans sachet plastique, plié en couches

Hantel-Etiketten

Dumbbell labels

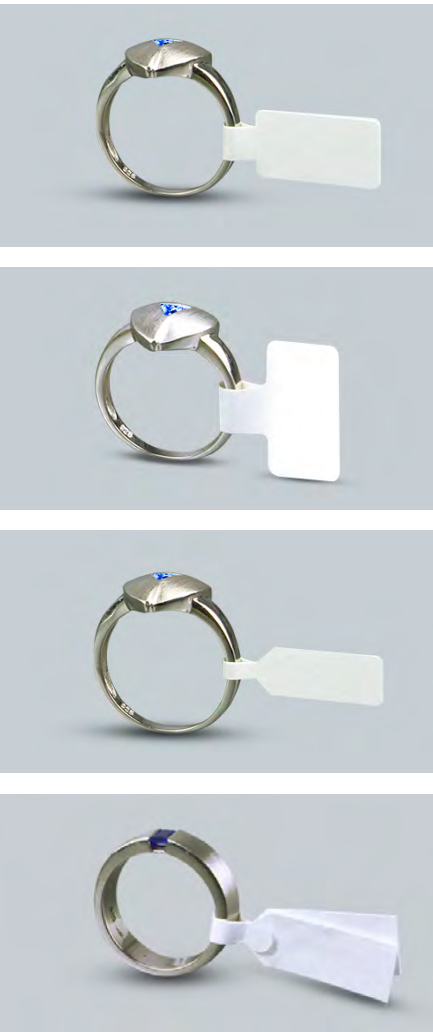
Étiquettes d'haltères



- B** Anzahl Bahnen |
Number of rows |
Nombre de poses
- BB** Bahnbreite |
Width of row |
Largeur de la bande
- T** Etikettenvorschub (Zoll) |
Label feed (inch) |
Avance des étiquettes (pouce)
-  Klassische Etiketten für die manuelle
Beschriftung | Classic labels for
writing on by hand | Étiquettes clas-
siques pour inscription manuelle
- *** Mit durchgestanzten Löchern |
With punched holes |
Avec des trous entièrement percés

34 848IR

B = 1, BB = 100 mm

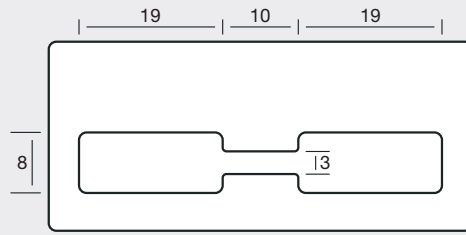

44 962

B = 1, BB = 88 mm, T = 3/6"

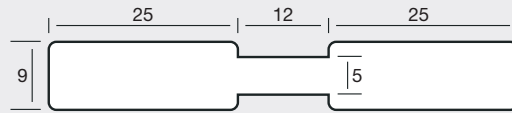

44 1046

B = 1, BB = 88 mm, T = 3/6"

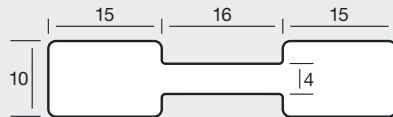

44 1048

B = 1, BB = 88 mm, T = 3/6"

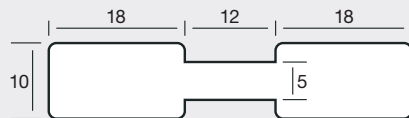

44 1052

B = 1, BB = 88 mm, T = 3/6"

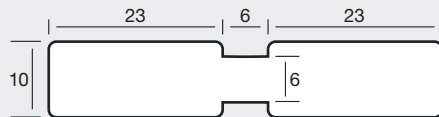

44 1061/2

B = 2, BB = 135 mm, T = 3/6"

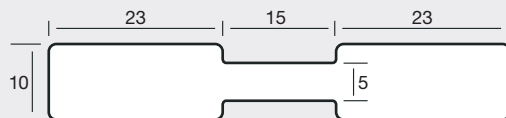

44 1062/5

B = 1, BB = 88 mm, T = 3/6"

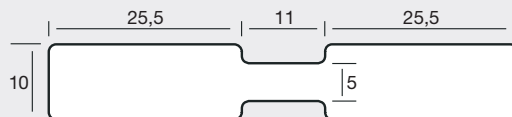

34 1066

B = 1, BB = 88 mm



44 1070/1

B = 1, BB = 88 mm, T = 3/6"

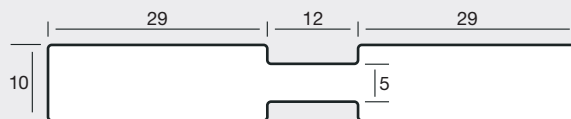

44 1160

B = 1, BB = 88 mm, T = 3/6"

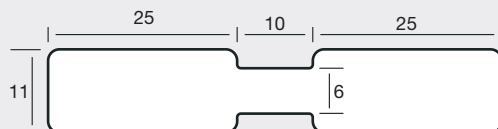

44 1161/2

B = 1, BB = 88 mm, T = 3/6"

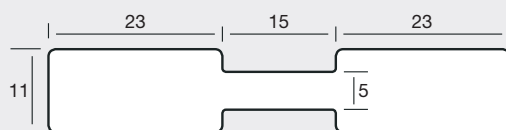

44 1162

B = 1, BB = 88 mm, T = 3/6"

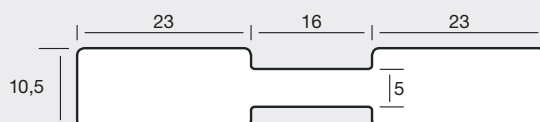

44 1162/1

B = 1, BB = 88 mm, T = 7/12"

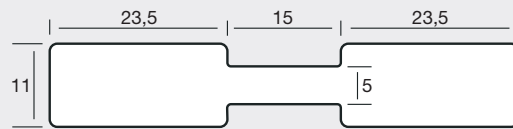
**44 1258**

B = 1, BB = 88 mm, T = 4/6"

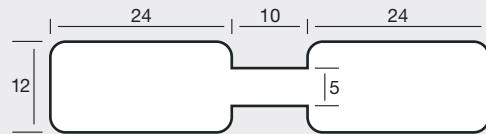
**44 1274**

B = 1, BB = 100 mm, T = 4/6"

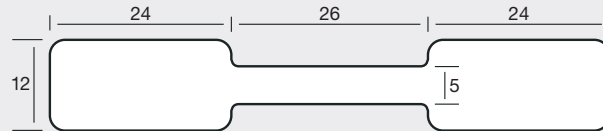
**44 1362**

B = 1, BB = 88 mm, T = 5/8"

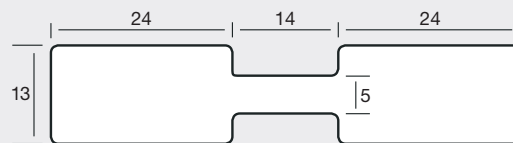
**44 1362/1**

B = 1, BB = 88 mm, T = 4/6"

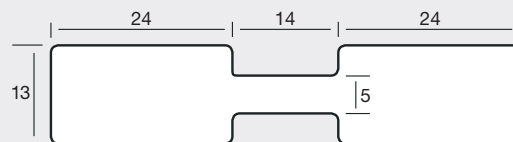
**44 1375**

B = 1, BB = 88 mm, T = 4/6"

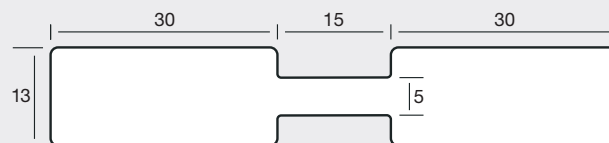
**44 1453**

B = 1, BB = 88 mm, T = 4/6"

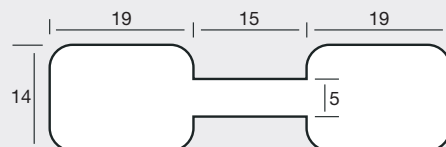
**34 1472/1**

B = 1, BB = 88 mm

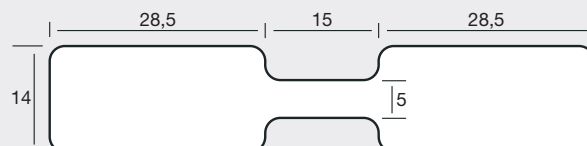
**34 1472/1IR**

B = 1, BB = 88 mm

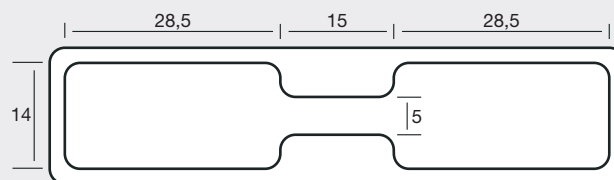
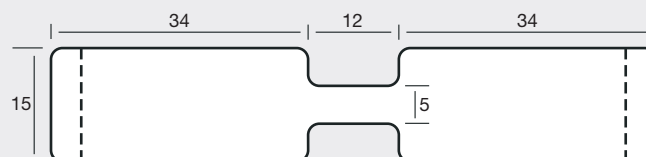
**34 1580**B = 1, BB = 88 mm
Mit Preisabriss**44 1653**

B = 1, BB = 88 mm, T = 6/8"

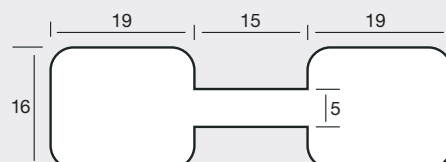

44 756

B = 1, BB = 93 mm, T = 5/12"

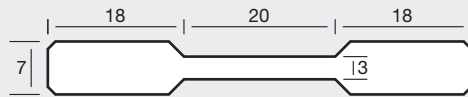

44 842/1

B = 2, BB = 120 mm, T = 3/6"

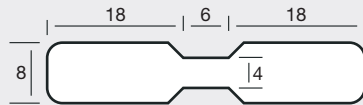

44 852/1

B = 1, BB = 88 mm, T = 3/6"

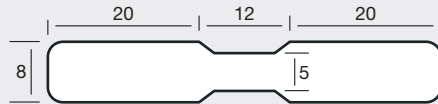

44 862

B = 1, BB = 88 mm, T = 3/6"

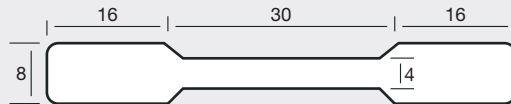

44 870

B = 1, BB = 88 mm, T = 3/6"

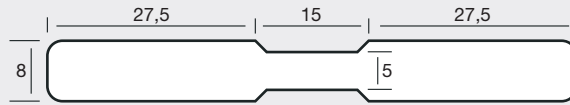

44 942

B = 1, BB = 63 mm, T = 3/6"

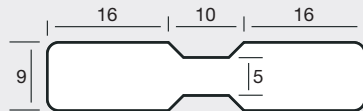

34 1050

B = 1, BB = 80 mm

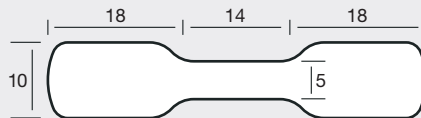

44 1052/1

B = 1, BB = 88 mm, T = 3/6"

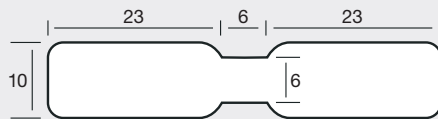

44 1052/3

B = 3, BB = 200 mm, T = 3/6"



44 1056

B = 1, BB = 88 mm, T = 3/6"

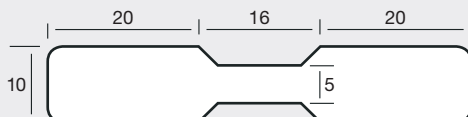

44 1056/6

B = 2, BB = 140 mm, T = 3/6"

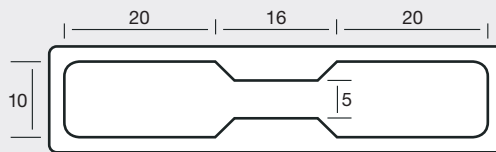

34 1056R

B = 1, BB = 88 mm

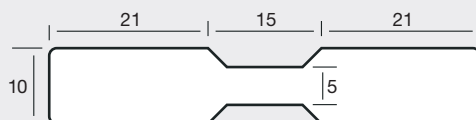

34 1057

B = 1, BB = 65 mm

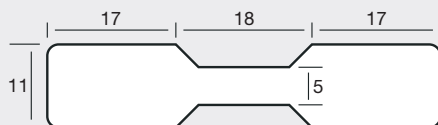

44 1152

B = 1, BB = 88 mm, T = 3/6"

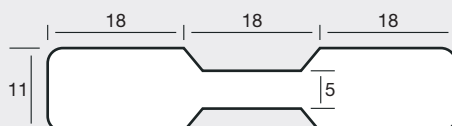

44 1154

B = 3, BB = 200 mm, T = 3/6"

44 1155

B = 1, BB = 88 mm, T = 3/6"

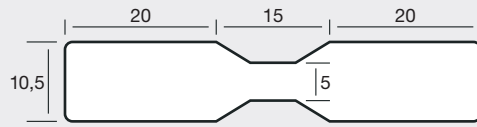

44 1156

B = 1, BB = 88 mm, T = 3/6"

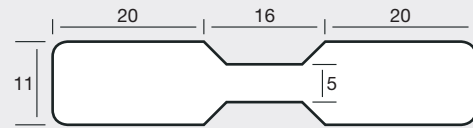

44 1160/1

B = 1, BB = 88 mm, T = 5/8"

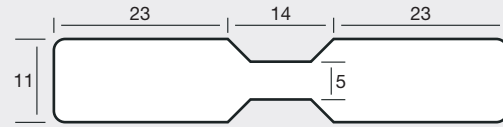

44 1246

B = 1, BB = 88 mm, T = 4/6"

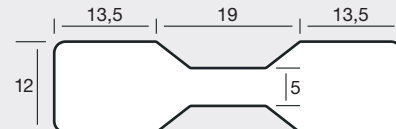

44 1253/2

B = 1, BB = 88 mm, T = 6/10"



44 1259

B = 1, BB = 88 mm, T = 3/6"

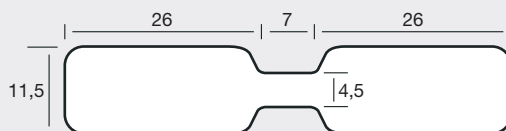

34 1259R

B = 1, BB = 88 mm

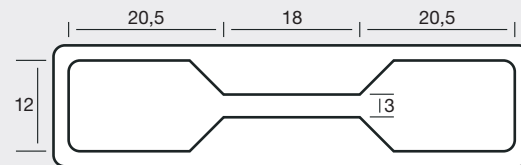

44 1260/2

B = 1, BB = 88 mm, T = 5/6"



44 1260/3

B = 1, BB = 88 mm, T = 4/6"

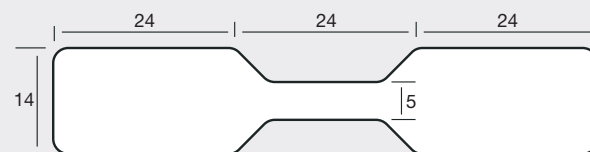

34 1472

B = 1, BB = 88 mm

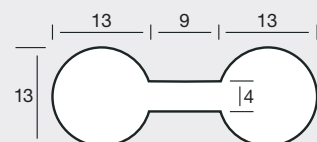

44 1335

B = 1, BB = 63 mm, T = 4/6"



44 1350

B = 1, BB = 88 mm, T = 4/6"

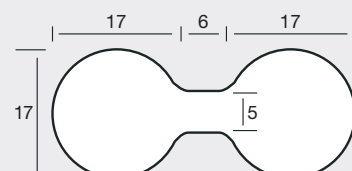

44 1740

B = 1, BB = 88 mm, T = 5/6"

TYP 1

34 1850

B = 2, BB = 110 mm

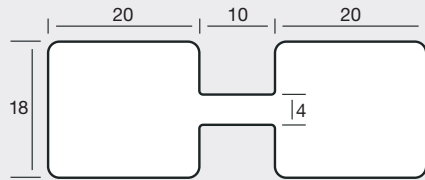

44 1936

B = 1, BB = 88 mm, T = 5/6"

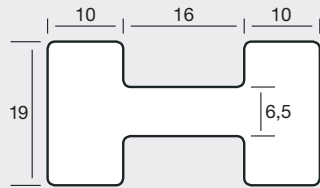

TYP 2

44 644

B = 1, BB = 80 mm, T = 2/6"

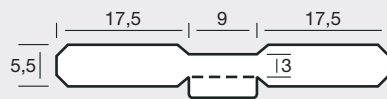

44 842/2

B = 1, BB = 70 mm, T = 3/6"

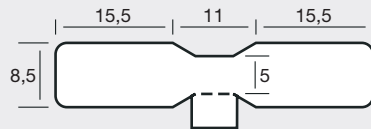

44 852

B = 1, BB = 80 mm, T = 3/6"

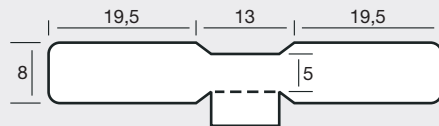

44 945

B = 2, BB = 120 mm, T = 3/6"

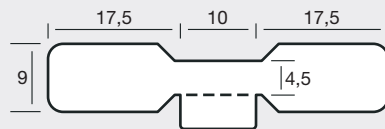

44 1056/2

B = 1, BB = 100 mm, T = 3/6"

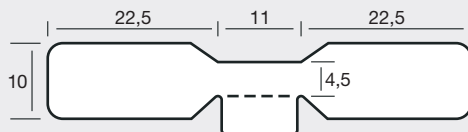

44 1061

B = 1, BB = 100 mm, T = 3/6"

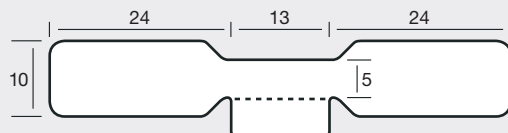

44 1068/1

B = 1, BB = 100 mm, T = 3/6"

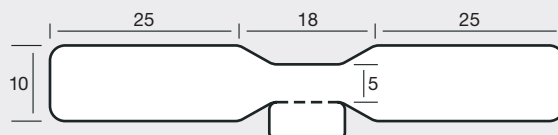

44 1260/1

B = 1, BB = 100 mm, T = 5/8"

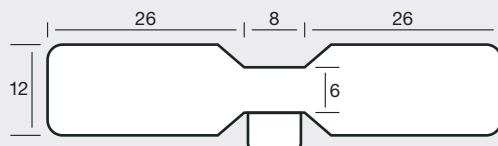

44 2067IR*

B = 1, BB = 88 mm, T = 6/6"

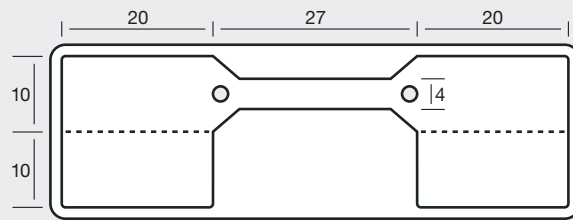
**44 2285***

B = 1, BB = 110 mm, T = 6/6"

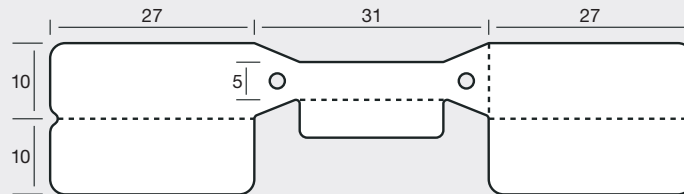
**44 2260***

B = 1, BB = 85 mm, T = 6/6"

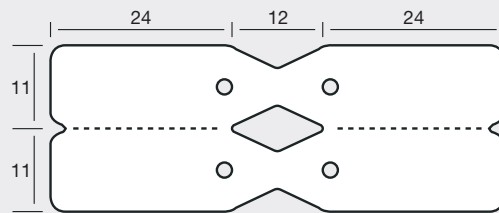

Zum sicheren Befestigen mit Plastik-Nieten oder Ringösen aus Aluminium |

Special shapes to fix with plastic rivets or aluminium rivets |

Pour une fixation durable avec des rivets en matière plastique ou des œillets de bagues en aluminium

44 3618

B = 3, BB = 100 mm, T = 12/6"

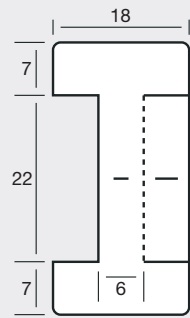

34 3618

B = 1, BB = 40 mm

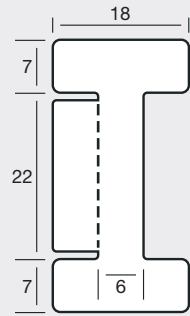

44 3619

B = 3, BB = 100 mm, T = 9/6"

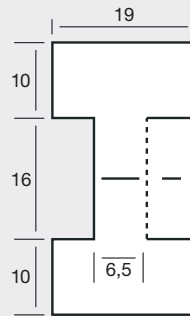

45 4023

B = 4, BB = 140 mm, T = 10/6"

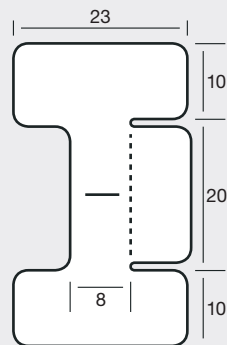

35 5233R

B = 1, BB = 50 mm

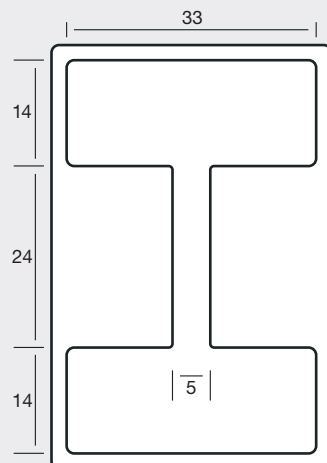



72 107K* 



72 81K* 

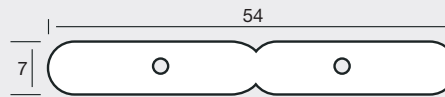

72 82K* 

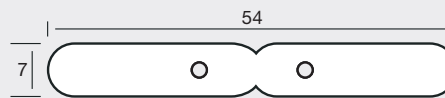

72 486K* 



72 D255K* 

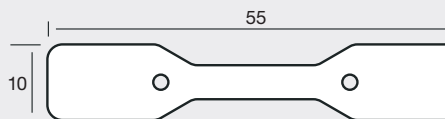

72 D258K* 

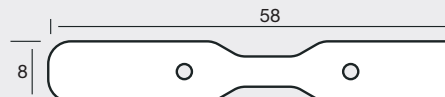

72 367L1* 

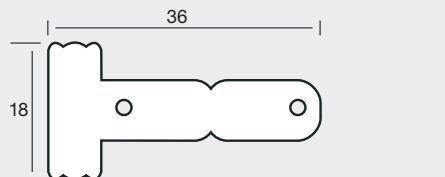

72 369L* 

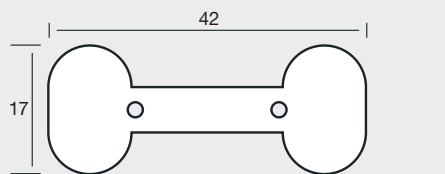

72 D305V[®] 

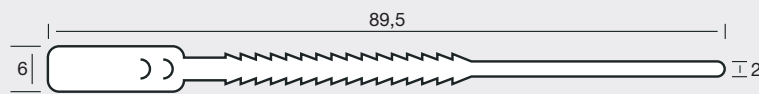

72 D306V[®] 

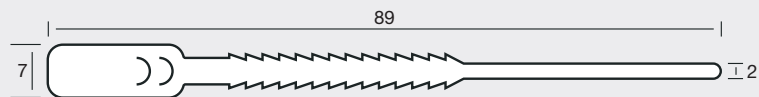



[®] langfristige Verfügbarkeit nicht gesichert

Faden-Etiketten

Tags, labels for threads

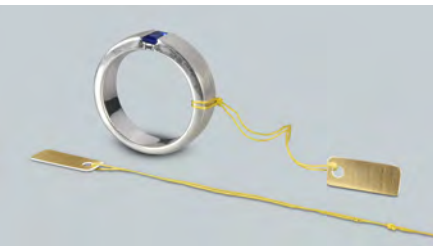
Étiquettes à fil



- B** Anzahl Bahnen |
Number of rows |
Nombre de poses
- BB** Bahnbreite |
Width of row |
Largeur de la bande
- T** Etikettenvorschub (Zoll) |
Label feed (inch) |
Avance des étiquettes (pouce)
-  Klassische Etiketten für die manuelle
Beschriftung | Classic labels for
writing on by hand | Étiquettes clas-
siques pour inscription manuelle
- *** Mit durchgestanzten Löchern |
With punched holes |
Avec des trous entièrement percés

34 726

B = 2, BB = 60 mm

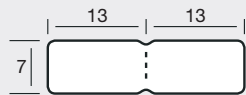

44 726

B = 4, BB = 140 mm, T = 5/12"

44 726/1

B = 1, BB = 80 mm, T = 3/6"



34 730IR

B = 2, BB = 90 mm

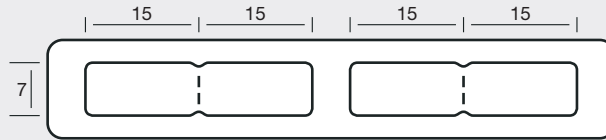

44 737

B = 2, BB = 100 mm, T = 3/6"

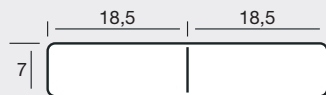

44 830

B = 2, BB = 80 mm, T = 3/6"

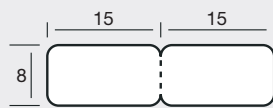

44 835/1

B = 2, BB = 100 mm, T = 3/6"

44 835/4

B = 1, BB = 60 mm, T = 3/6"



44 835

B = 1, BB = 80 mm, T = 3/6"

44 835/2

B = 2, BB = 100 mm, T = 3/6"

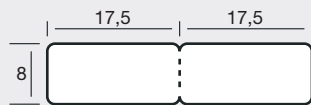

34 835IR

B = 1, BB = 120 mm

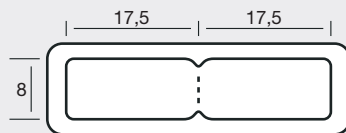

44 852/2

B = 1, BB = 100 mm, T = 3/8"



34 926

B = 2, BB = 60 mm

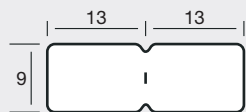

34 930IR

B = 2, BB = 90 mm

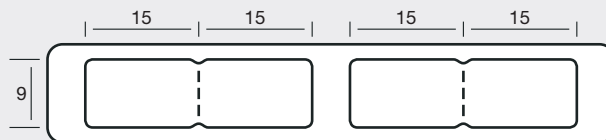

44 935

B = 1, BB = 60 mm, T = 3/6"

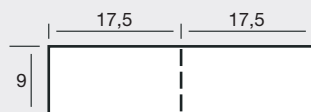

44 940

B = 1, BB = 70 mm, T = 3/6"



44 1032

B = 2, BB = 90 mm, T = 3/6"

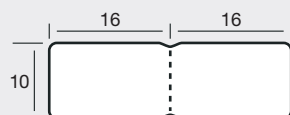

44 1038

B = 2, BB = 100 mm, T = 3/6"

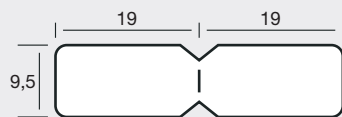

44 1038/1

B = 1, BB = 80 mm, T = 3/6"

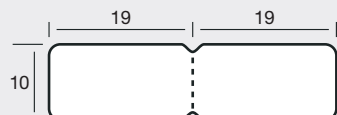

44 1042/1

B = 2, BB = 120 mm, T = 3/6"

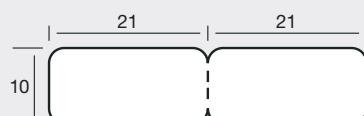

34 1044

B = 1, BB = 60 mm

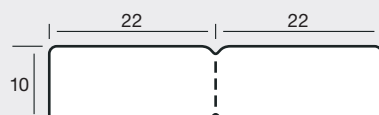

44 1047

B = 1, BB = 80 mm, T = 3/6"



44 1047/1

B = 2, BB = 130 mm, T = 3/6"

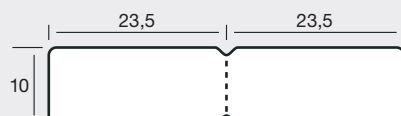

34 1152

B = 1, BB = 80 mm

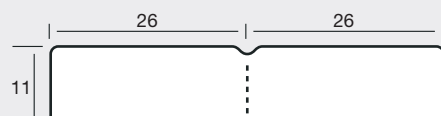

44 1152/1

B = 1, BB = 80 mm, T = 3/6"

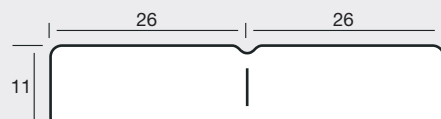

34 1248

B = 2, BB = 120 mm, T = 10/17"

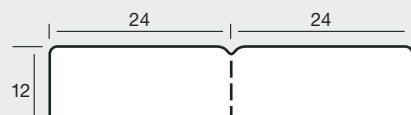

35 1248*

B = 1, BB = 80 mm

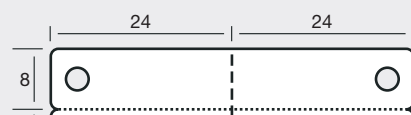

34 1340

B = 1, BB = 60 mm

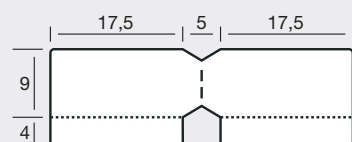

44 1438

B = 1, BB = 70 mm, T = 4/6"

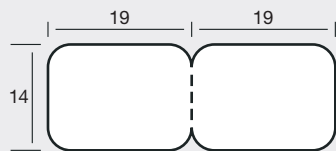

45 1524*

B = 1, BB = 50 mm, T = 6/8"

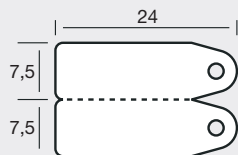

35 2026*

B = 1, BB = 40 mm

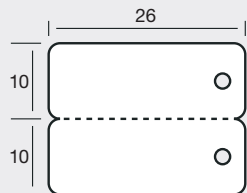

45 2028*

B = 1, BB = 60 mm, T = 6/6"

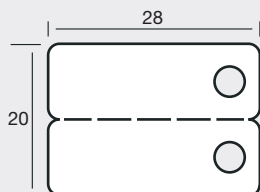

45 2219*

B = 1, BB = 44 mm, T = 6/6"

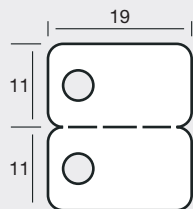

35 3225*

B = 1, BB = 40 mm

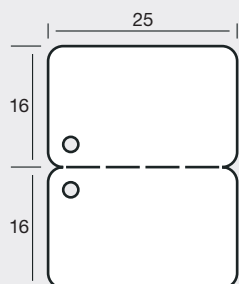

35 3524*

B = 1, BB = 60 mm

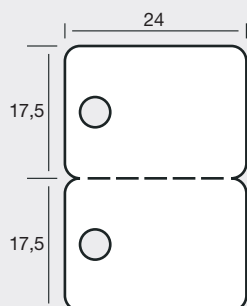

35 3045*

B = 1, BB = 60 mm

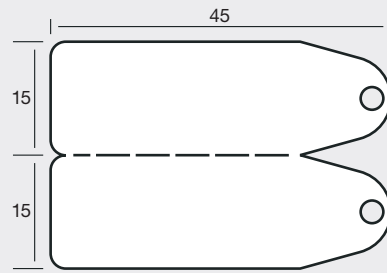

35 3244*

B = 1, BB = 60 mm

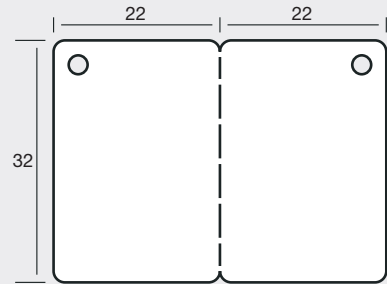

35 4050/1*

B = 1, BB = 60 mm

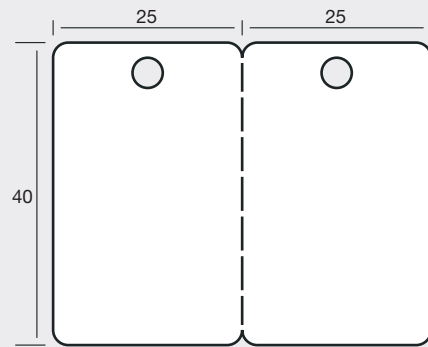

45 4850/2*

B = 1, BB = 65 mm, T = 12/6"

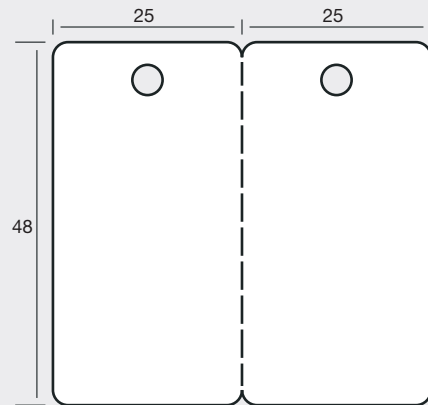

34 5054*

B = 1, BB = 60 mm

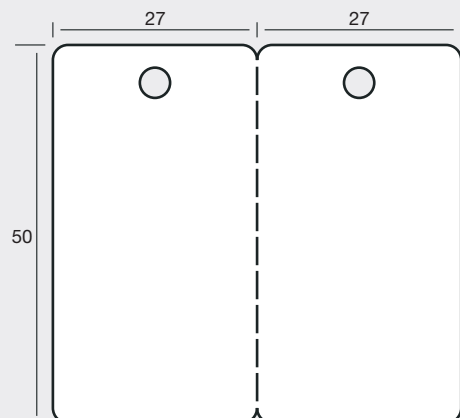

35 2745*

B = 1, BB = 60 mm
WrapTag

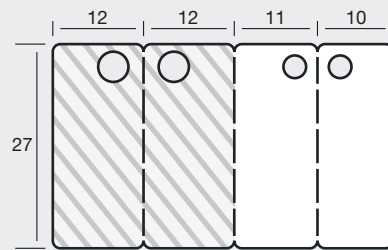

35 3065*

B = 1, BB = 90 mm
WrapTag

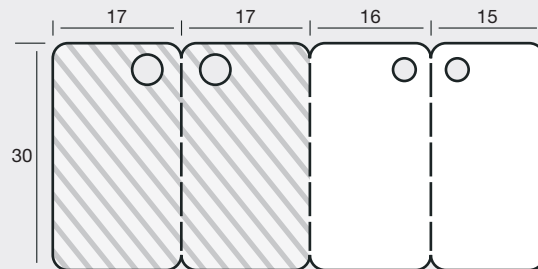

35 3865*

B = 1, BB = 90 mm
WrapTag

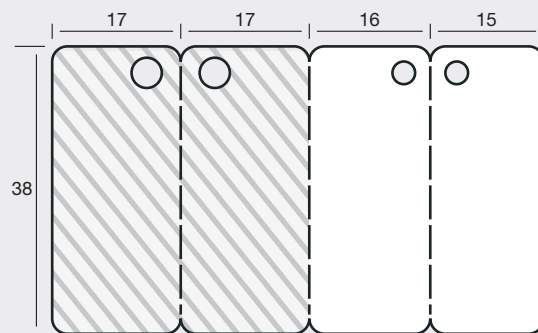

Transparente Schutz- und
Verstärkungsfolie |
Transparent foil of streng-
thening and protection |
Feuille transparente de
protection et renforcement

Weißer Beschriftungsfelder |
White labelling fields |
Champs d'inscription blancs



Mit Faden, eingeknotet, nutzbare Länge 6 cm |
With cotton thread, knotted, usable length 6 cm |
Avec fil de coton, noué, d'une longueur utile de 6 cm

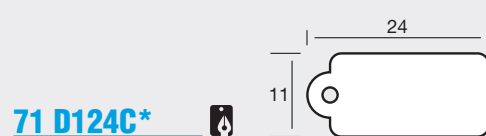
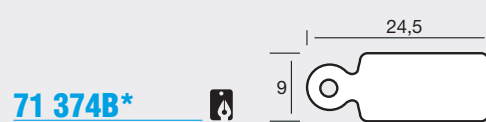
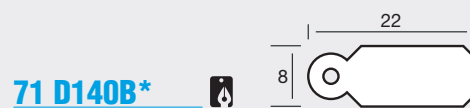



Mit Faden, eingeknotet, nutzbare Länge 6 cm |
With cotton thread, knotted, usable length 6 cm |
Avec fil de coton, noué, d'une longueur utile de 6 cm

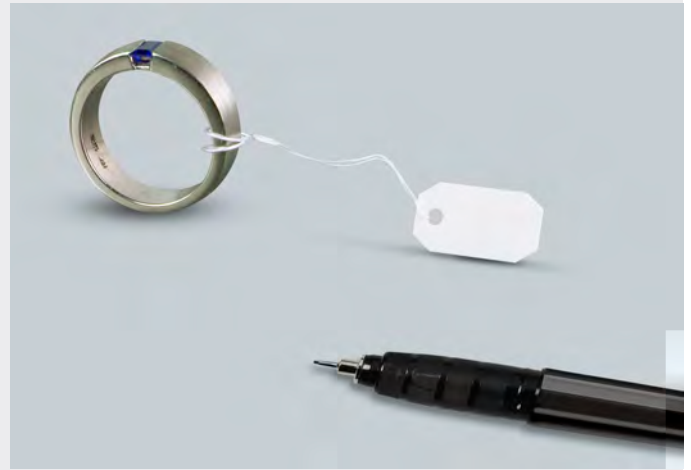

71 175A*

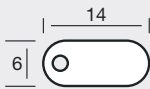

71 756C*

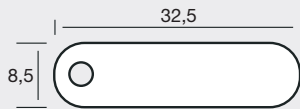

71 D116A*



71 D118A*

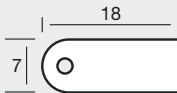

71 40A*

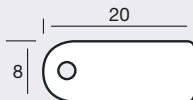

71 93A*

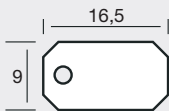

71 43C*

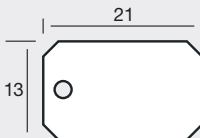

71 25C*

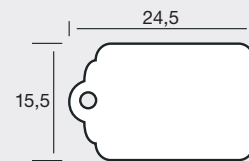

71 385D*

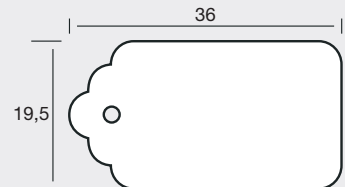

71 44E*

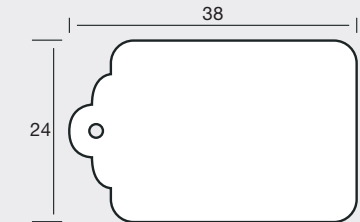

Etiketten für Ketten

Labels for chains | Etiquettes pour chaînes

Etiketten für Ohrringe

Labels for earrings | Etiquettes pour boucles d'oreille

Etiketten für Perl-Schnüre

Labels for pearl-strings | Etiquettes pour perles



- B** Anzahl Bahnen |
Number of rows |
Nombre de poses
- BB** Bahnbreite |
Width of row |
Largeur de la bande
- T** Etikettenvorschub (Zoll) |
Label feed (inch) |
Avance des étiquettes (pouce)
-  Klassische Etiketten für die manuelle
Beschriftung | Classic labels for
writing on by hand | Etiquettes clas-
siques pour inscription manuelle
- *** Mit durchgestanzten Löchern |
With punched holes |
Avec des trous entièrement percés

35 841*

B = 1, BB = 60 mm

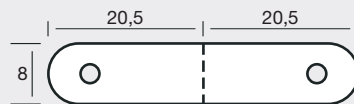

45 852*

B = 1, BB = 100 mm, T = 3/6"

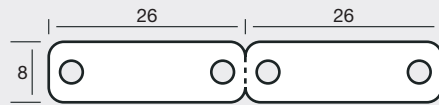

44 1049*

B = 1, BB = 80 mm, T = 3/6"

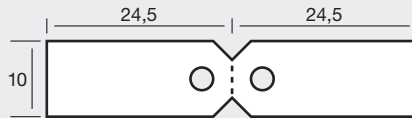

44 1049/1*

B = 1, BB = 70 mm, T = 3/6"

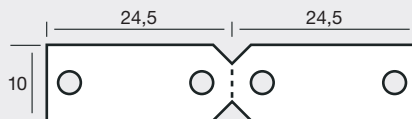

45 1070*

B = 1, BB = 100 mm, T = 3/6"

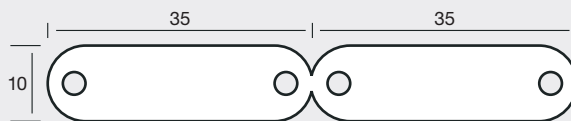

45 1270/1*

B = 1, BB = 90 mm, T = 3/6"

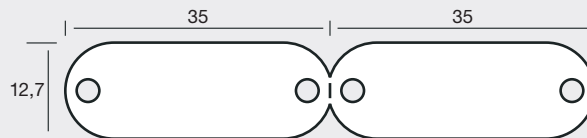

45 1270/3*

B = 1, BB = 120 mm, T = 3/6"

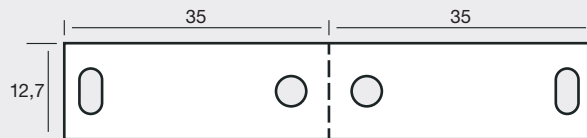

45 1276*

B = 1, BB = 120 mm, T = 3/6"

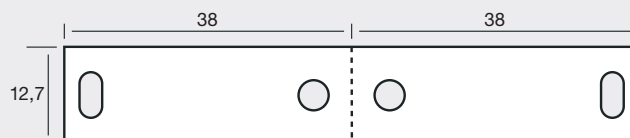

45 1467*

B = 1, BB = 100 mm, T = 4/6"

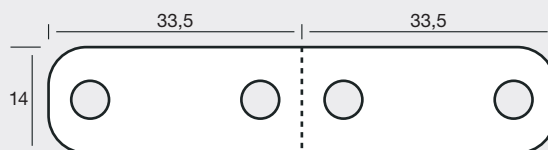

35 1425*

B = 2, BB = 80 mm

B = 1, BB = 40 mm

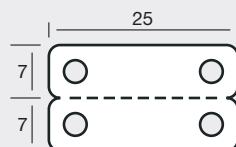

35 1626*

B = 1, BB = 60 mm

Lochabstand 20 mm

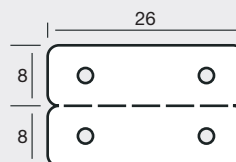

35 1626/1*

B = 1, BB = 60 mm

Lochabstand 16 mm

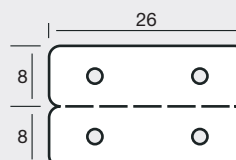

45 2032*

B = 1, BB = 60 mm, T = 6/6"
 passend für KLING-Laden |
 suitable for KLING-trays |
 convient aux plateaux
 de KLING

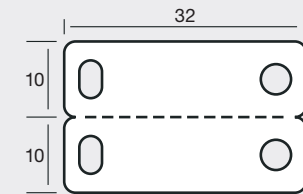

35 2138*

B = 2, BB = max. 110 mm

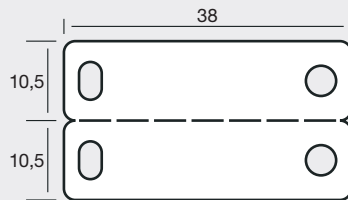

45 2234*

B = 2, BB = 120 mm, T = 6/6"

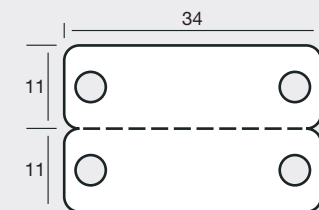

45 2235*

B = 2, BB = 120 mm, T = 6/6"
 Lochabstand 1 mm vom
 Rand |
 1 mm distance from hole
 to margin |
 Espacement des trous à
 1 mm de bord

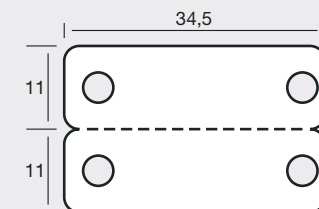

45 2241*

B = 2, BB = 110 mm, T = 6/6"

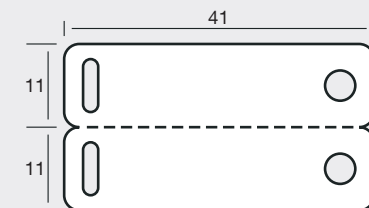

45 2241/1*

B = 1, BB = 80 mm, T = 6/6"

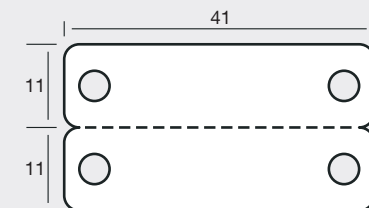

45 2241/2*

B = 2, BB = 100 mm, T = 6/6"

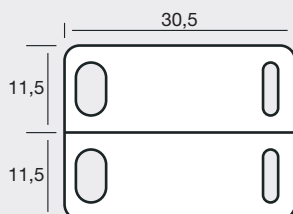

45 2330*

B = 3, BB = 120 mm, T = 6/6"

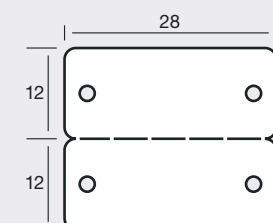

35 2428*

B = 1, BB = 40 mm

45 2432*

B = 1, BB = 60 mm, T = 7/6"

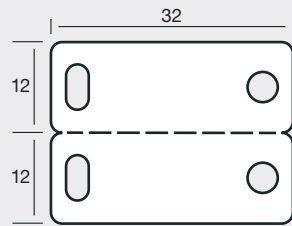

35 2435*

B = 2, BB = 100 mm

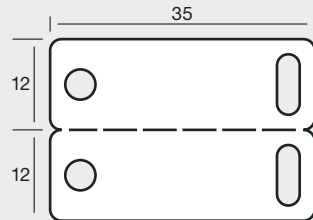

45 2435/1*

B = 2, BB = 100 mm, T = 6/6"

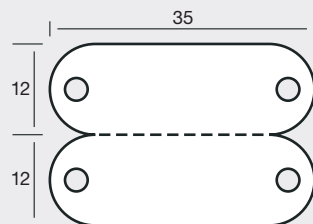

45 2435*

B = 1, BB = 60 mm, T = 6/6"

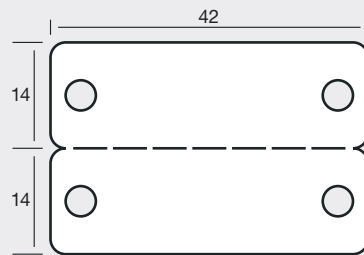

35 2842/1*

B = 2, BB = max. 110 mm

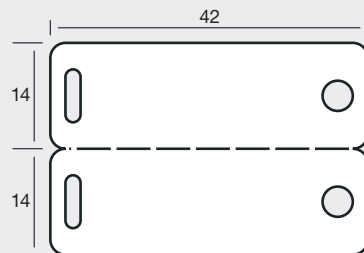

35 2842/2*

B = 2, BB = max. 110 mm

45 1923*

B = 4, BB = 130 mm, T = 6/6"

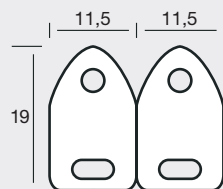

45 2524*

B = 1, BB = 60 mm, T = 6/6"

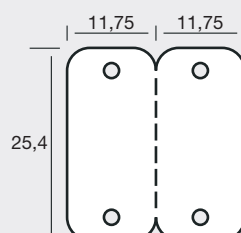

45 3042*

B = 1, BB = 70 mm, T = 8/6"

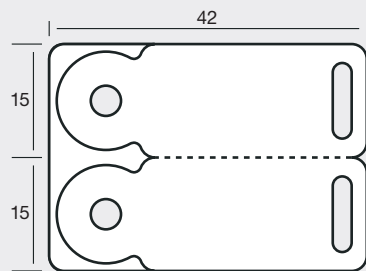

45 3830*

B = 2, BB = 100 mm, T = 12/6"

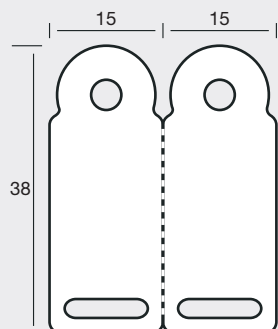

45 3535*

B = 1, BB = 60 mm, T = 9/6"

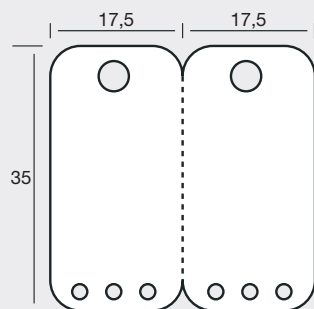

45 2282*

B = 1, BB = 100 mm, T = 6/6"

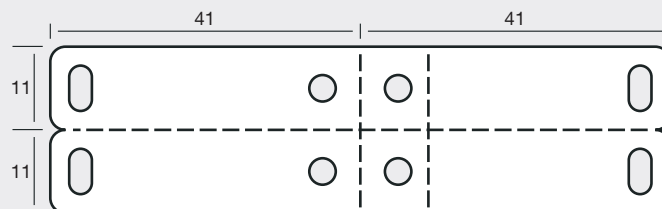

45 2288*

B = 1, BB = 120 mm, T = 6/6"

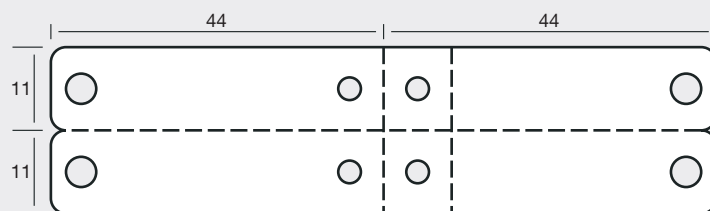

45 1335*

B = 3, BB = 130 mm, T = 3/6"
für nicht selbstklebende
Papiere, Folien und Ver-
bundfolien |
for non-adhesive papers,
foils and compound foils |
pour papiers, pellicules
et composites non auto-
collants

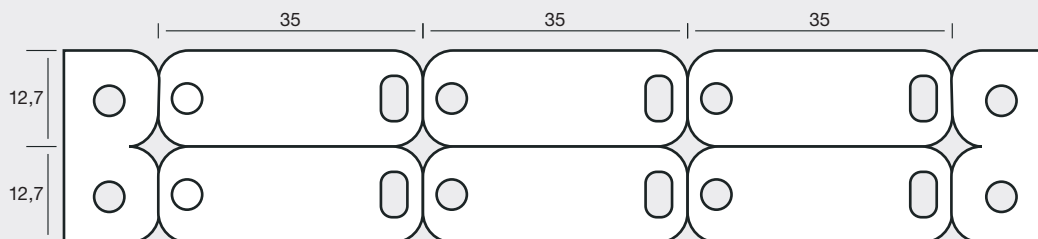

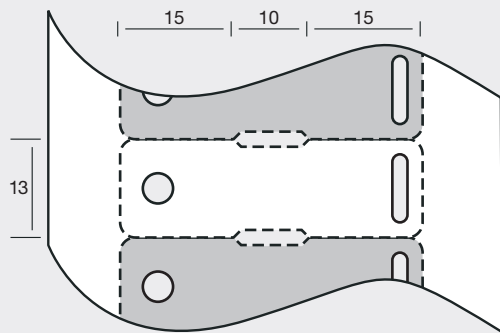

35 1340/2*

B = 1, BB = 40 mm

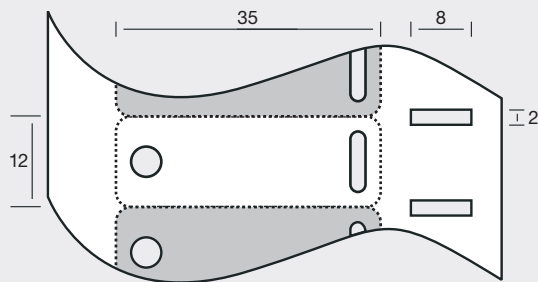

35 1235*

B = 1, BB = 60 mm, T = ∅

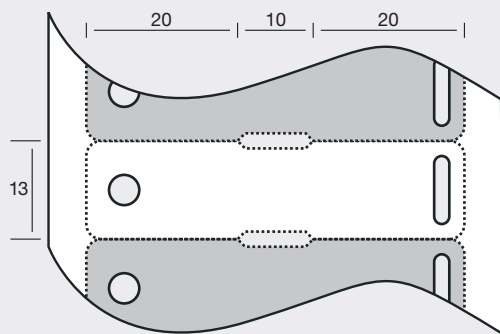

35 1350*

B = 1, BB = 50 mm

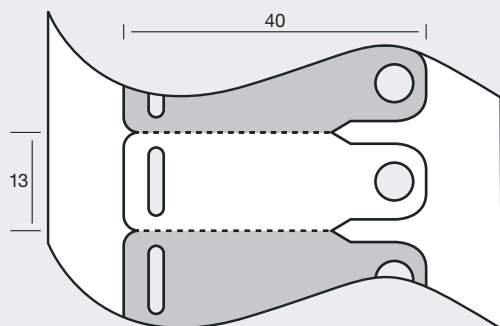

35 1340/1*

B = 1, BB = 40 mm

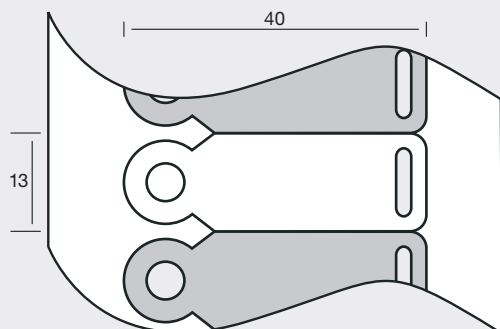

35 1340*











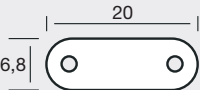

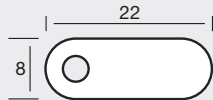

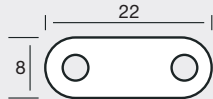
B = 1, BB = 40 mm

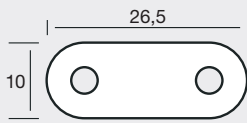

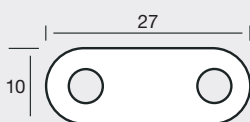

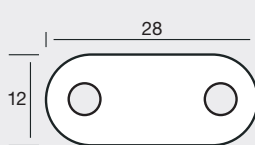

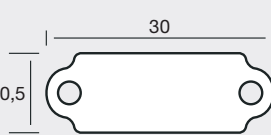
Etikett mit mikroperforierter Kontur für nicht selbstklebende Papiere, Folien und Verbundfolie, mit Führungsloch für Thermotransfer-Drucker |

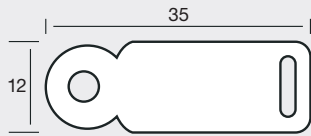
Label with micro-perforated outline for non-adhesive papers, foils and compound foils with guide hole for thermal transfer printers |

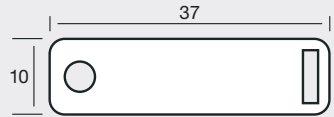
Etiquette à contours microperforés pour papiers, pellicules et composites non autocollants, avec trou de guidage pour imprimante transfert thermique

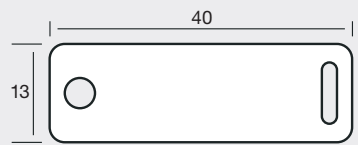

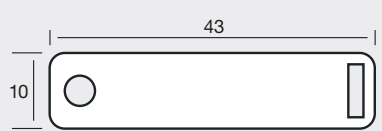
- 73 D420F***  
- 73 89F***  
- 73 143F***  
- 73 D424G***  
- 73 88G***  
- 73 460/2G***  
- 73 377/2G***  
- 73 116/2G***  

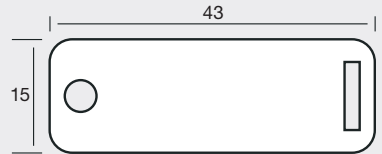
- 73 33/2G***  
- 73 31/2G***  
- 73 30G***  
- 73 62G***  

45 1932*

B = 3, BB = 130 mm, T = 6/6"

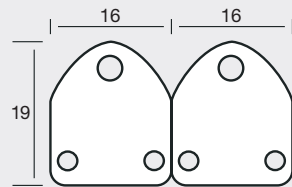

35 1932IR*

B = 1, BB = 50 mm

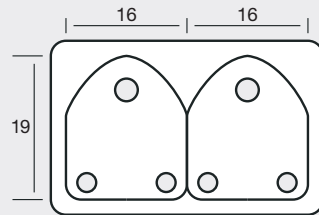

35 1932/1R*

B = 2, BB = 100 mm

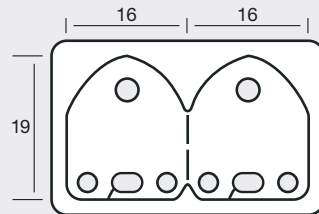

35 2236*

B = 1, BB = 40 mm

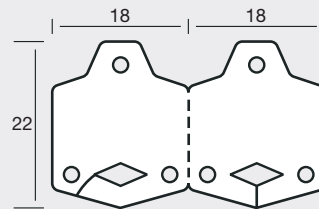

35 2440IR*

B = 1, BB = 60 mm

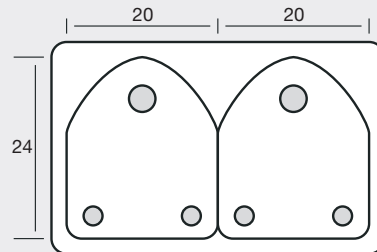

35 1932/2R*

B = 2, BB = 100 mm

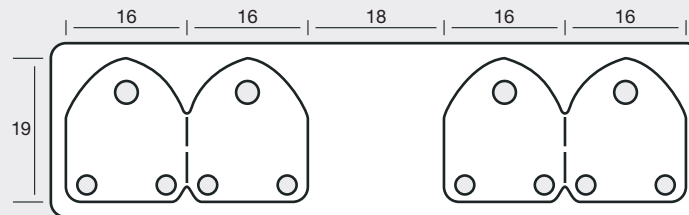

35 1932/3R*

B = 2, BB = 100 mm

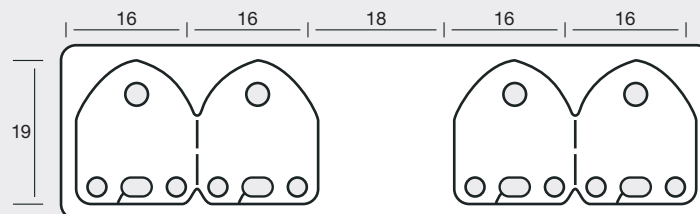

35 2440/2IR*

B = 2, BB = 108 mm

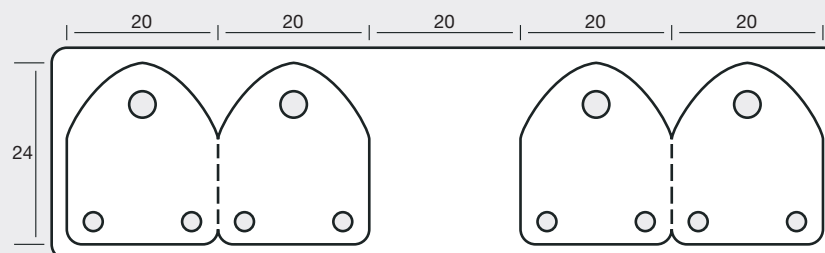

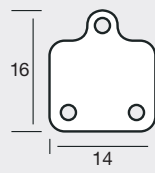

74 528/3N* 

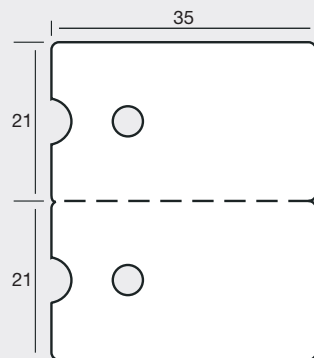

49 4235*

B = 1, BB = 80 mm, T = 12/6"

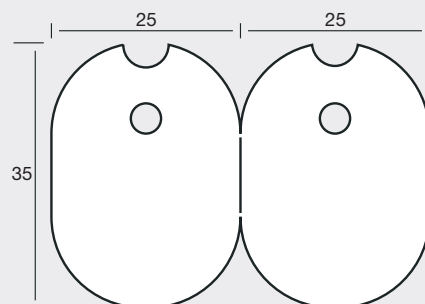

49 3550*

B = 2, BB = 130 mm, T = 9/6"

49 3550/1*

B = 1, BB = 70 mm, T = 9/6"

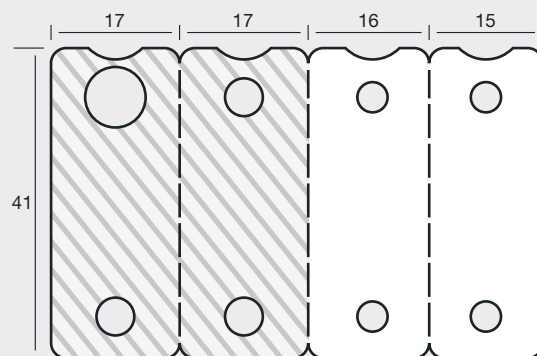

34 4165*

B = 1, BB = 80 mm
 WrapTag Selbstlaminiertes Etikett |
 WrapTag Self-laminating labels |
 WrapTag Etiquettes á auto-laminage

Transparente Schutz- und Verstärkungsfolie |
 Transparent foil of strengthening and protection |
 Feuille transparente de consolidation et protection

Weißer Beschriftungsbereich |
 White labelling area |
 Cases d'inscriptions blanches

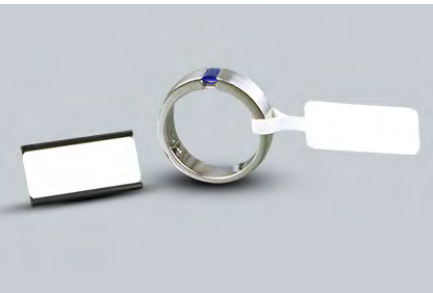

Form-Kombinationen

Combinations | Combinaisons

Etiketten für Schreibgeräte

Labels for writing utensils | Etiquettes outils pour écrire

Schmuck-Zertifikate

Card Labels for certificates | Cartes de certificats

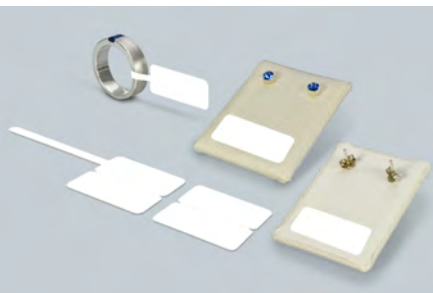

- B** Anzahl Bahnen |
Number of rows |
Nombre de poses
- BB** Bahnbreite |
Width of row |
Largeur de la bande
- T** Etikettenvorschub (Zoll) |
Label feed (inch) |
Avance des étiquettes (pouce)



Klassische Etiketten für die manuelle
Beschriftung | Classic labels for
writing on by hand | Etiquettes clas-
siques pour inscription manuelle

*

Mit durchgestanzten Löchern |
With punched holes |
Avec des trous entièrement percés

36 789/1R

B = 1, BB = 120 mm

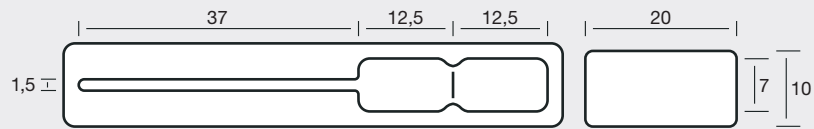

36 897/1R

B = 1, BB = 120 mm

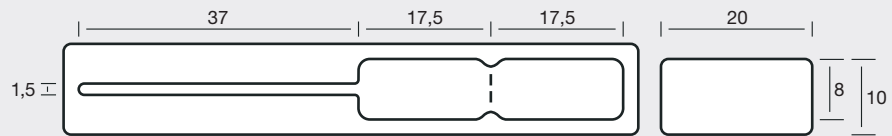

36 11105

B = 1, BB = 130 mm
Ring-Etikett mit leimfreiem
Mittelsteg und Kartuschen-
Etikett zur Auszeichnung
von Waren speziell für
Versandhaus Klingel

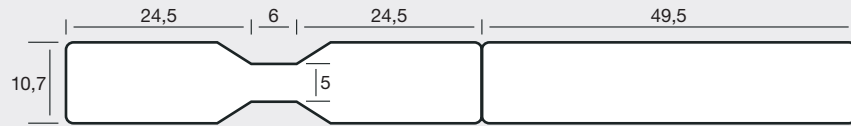

46 11108

B = 1, BB = 130 mm, T = 3/6"
Ring-Etikett mit leimfreiem
Mittelsteg und Kartuschen-
Etikett zur Auszeichnung
von Waren speziell für
Versandhaus Klingel

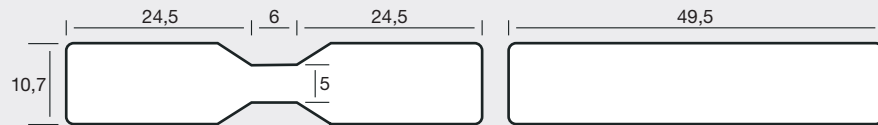

36 1455

B = 1, BB = 80 mm, T = 4/6"

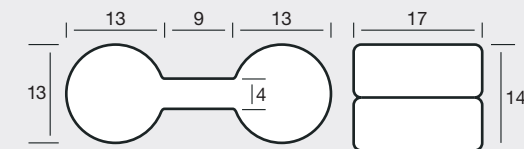

36 9911R

B = 1, BB = 120 mm

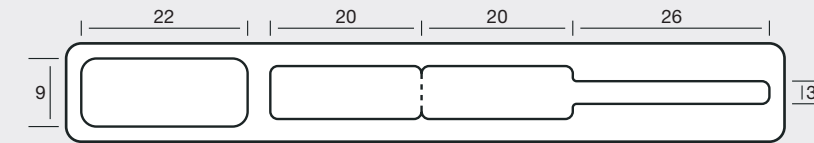

46 1087

B = 1, BB = 110 mm, T = 3/6"

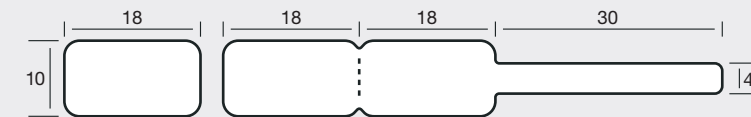

46 1089

B = 1, BB = 110 mm, T = 3/6"

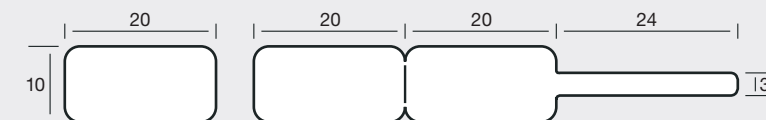

36 1094

B = 1, BB = 100 mm



46 1095

B = 1, BB = 110 mm, T = 3/6"

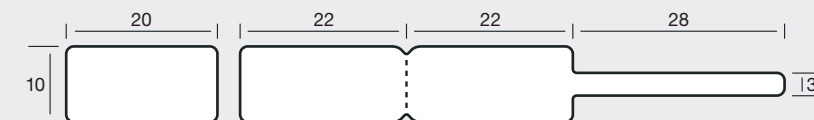

46 1098

B = 1, BB = 110 mm, T = 3/6"

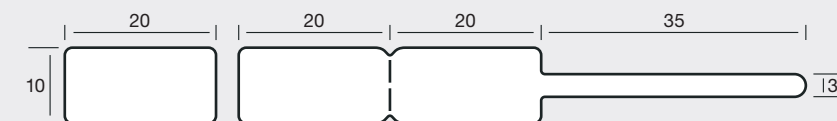

46 10100

B = 1, BB = 130 mm, T = 3/6"

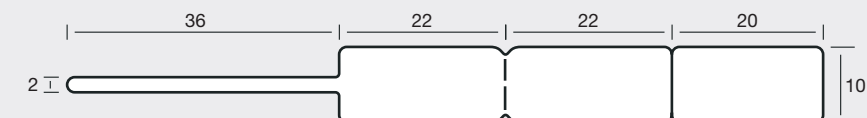

46 10100/2

B = 1, BB = 110 mm, T = 3/6"

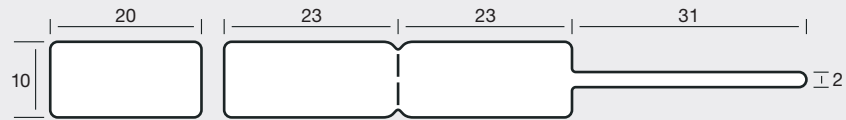

36 10101

B = 1, BB = 110 mm, T = 3/6"

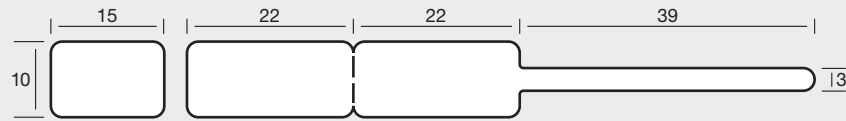

36 1295

B = 1, BB = 110 mm

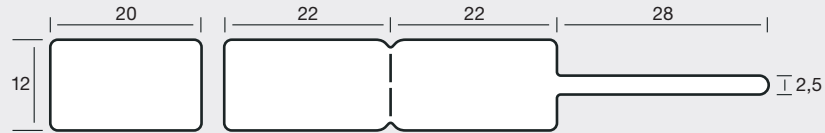

46 1166

B = 1, BB = 80 mm, T = 4/6"
funktionsgleich mit Etikett
T-220 von ZETAGS |
same function as label
T-220 from ZETAGS |
même fonction avec
l'étiquette T-220 de ZETAGS

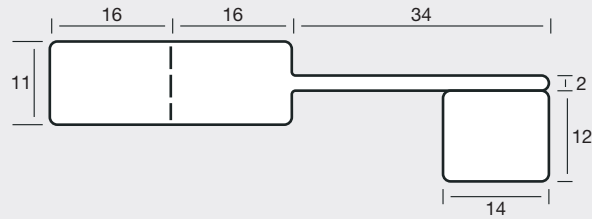

36 1184

B = 1, BB = 100 mm

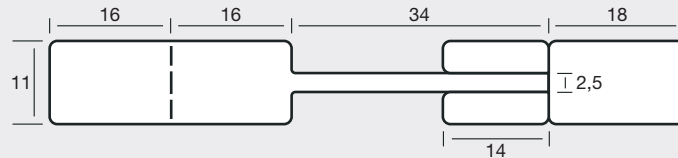

36 1184/2

B = 1, BB = 96 mm

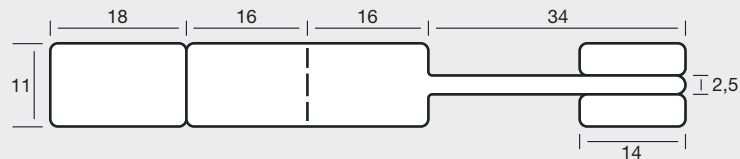

46 1186

B = 1, BB = 110 mm, T = 3/6"

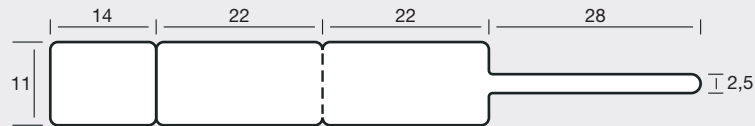

46 1255

B = 1, BB = 88 mm, T = 5/8"

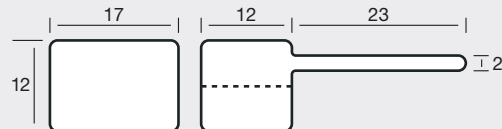

46 1667

B = 1, BB = 88 mm, T = 6/8"

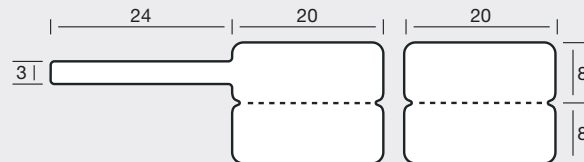

46 1682

B = 1, BB = 110 mm, T = 6/8"

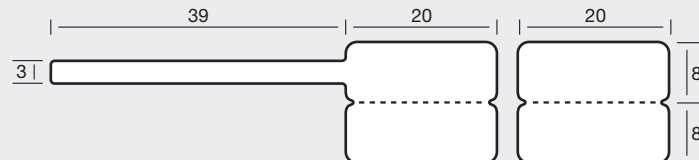

46 2067

B = 1, BB = 88 mm, T = 6/6"

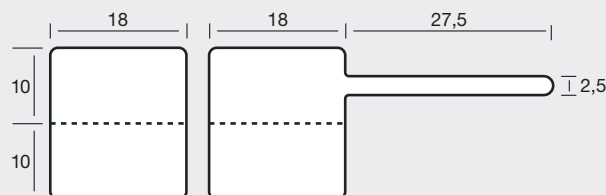

46 2071

B = 1, BB = 88 mm, T = 6/6"

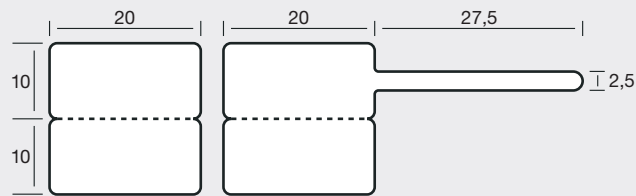

36 2071

B = 1, BB = 90 mm

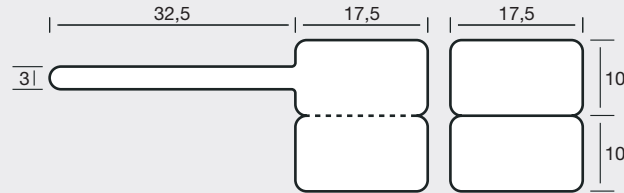

36 2083/1

B = 1, BB = 110 mm

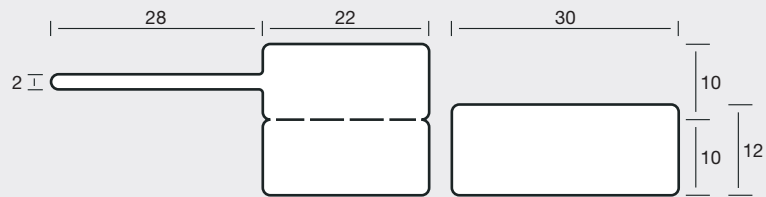

44 1742

B = 2, BB = 110 mm, T = 5/6"

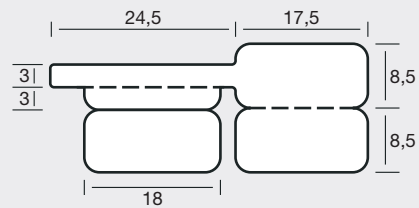

44 2042/2

B = 2, BB = 110 mm, T = 6/6"

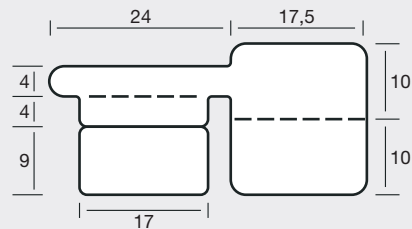

34 2957

B = 1, BB = 80 mm

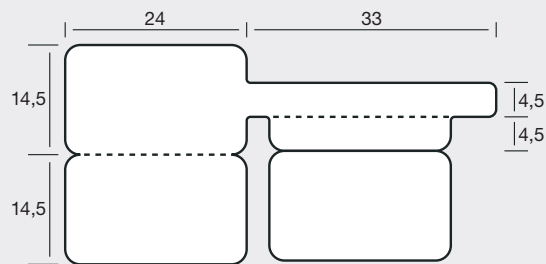

34 3042

B = 2, BB = 100 mm

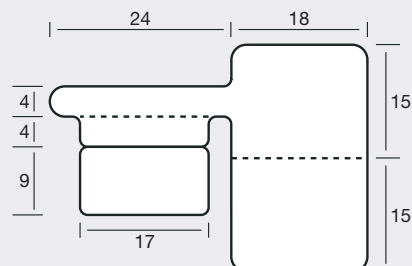

46 2076

B = 1, BB = 120 mm, T = 6/6"

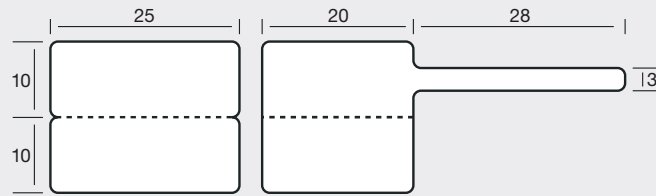

36 2078

B = 1, BB = 90 mm

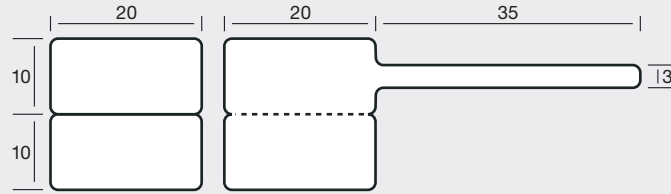

36 2079

B = 1, BB = 90 mm

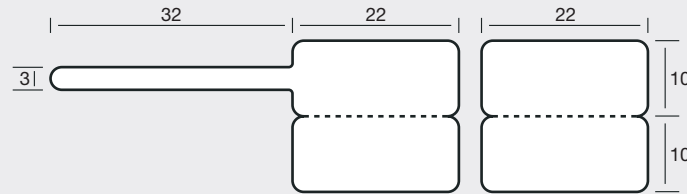

36 2079/1L*

B = 1, BB = 90 mm

Fadenloch \varnothing 1 mm

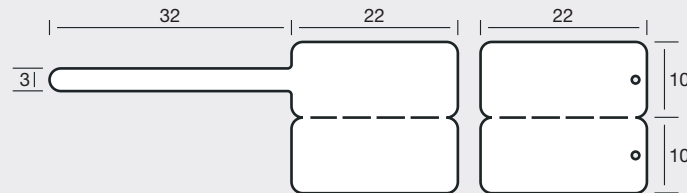

46 2365

B = 1, BB = 88 mm, T = 6/6"

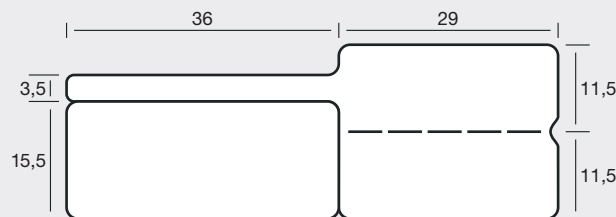

46 23104

B = 1, BB = 108 mm, T = 6/6"

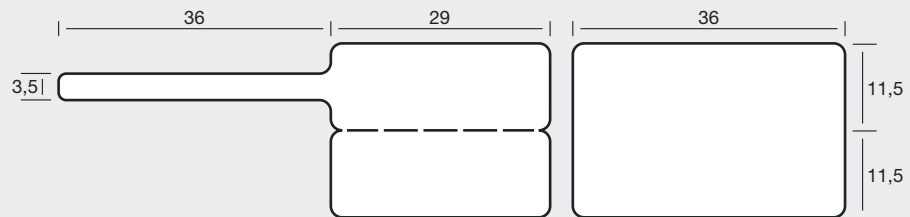

36 2483

B = 1, BB = 110 mm

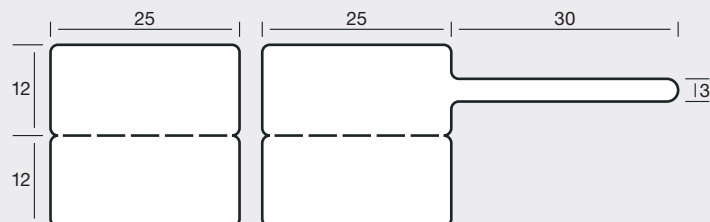

36 2493

B = 1, BB = 110 mm

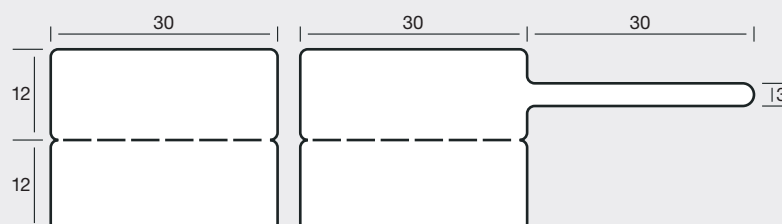

36 1976R*

B = 1, BB = 90 mm

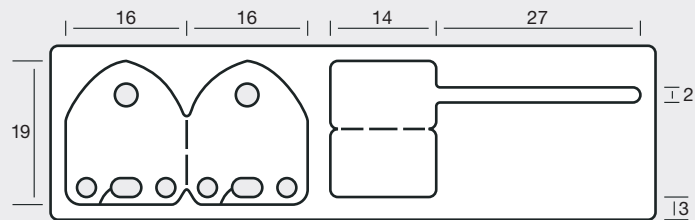

46 2076*

B = 1, BB = 120 mm, T = 6/6"

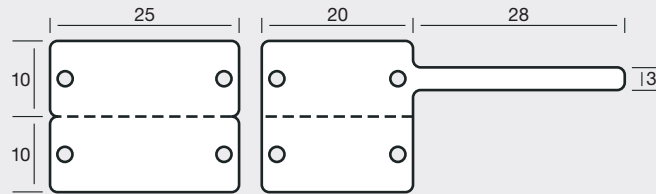

46 2296*

B = 1, BB = 135 mm, T = 6/6"

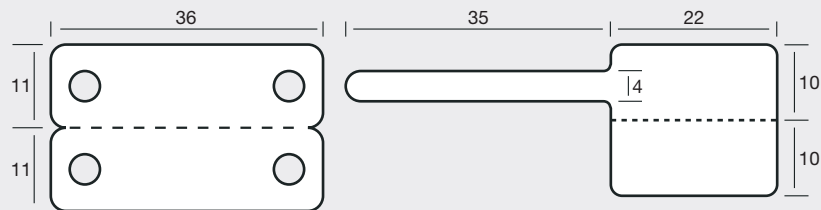

36 2576IR*

B = 1, BB = 130 mm

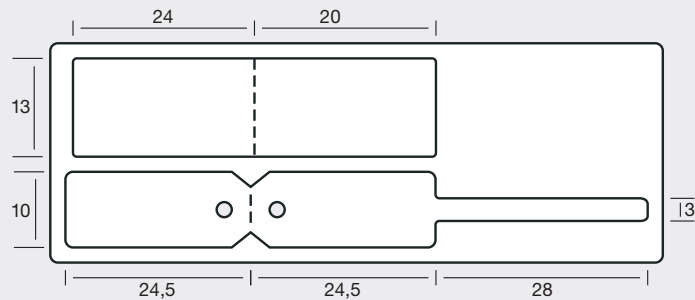

36 2593

B = 1, BB = 110 mm

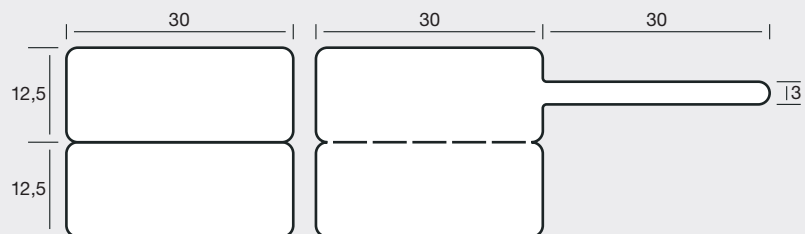

36 26103R

B = 1, BB = 125 mm

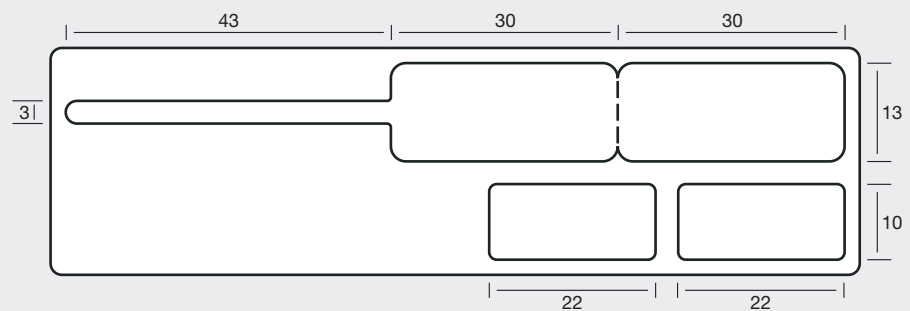

36 3079

B = 1, BB = 90 mm

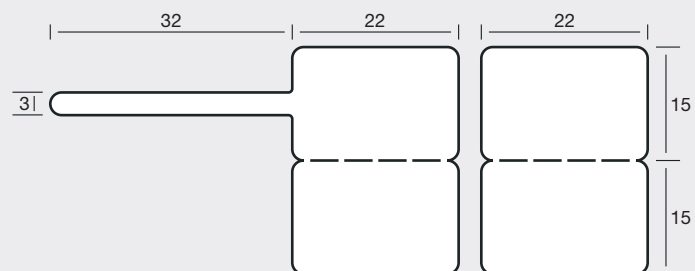

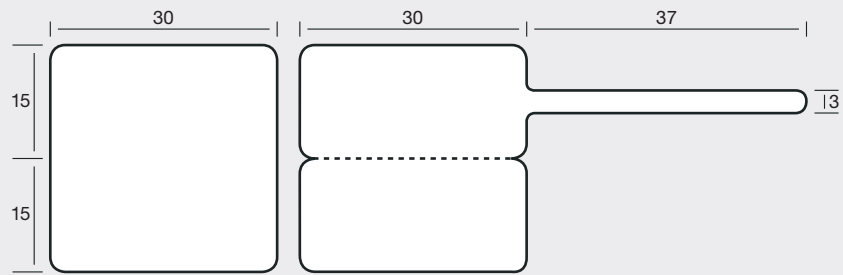

46 30100

B = 1, BB = 130 mm, T = 12/9"

Etiketten für Schreibgeräte | Labels for writing utensils | Etiquettes pour outils pour écrire

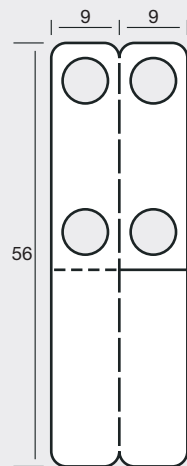

35 1856*

B = 1, BB = 70 mm

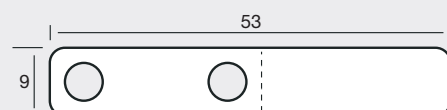

73 539*



37 5485S*

B = 1, BB = 85 mm

Scheckkartenformat |
credit card size |
format carte de crédit

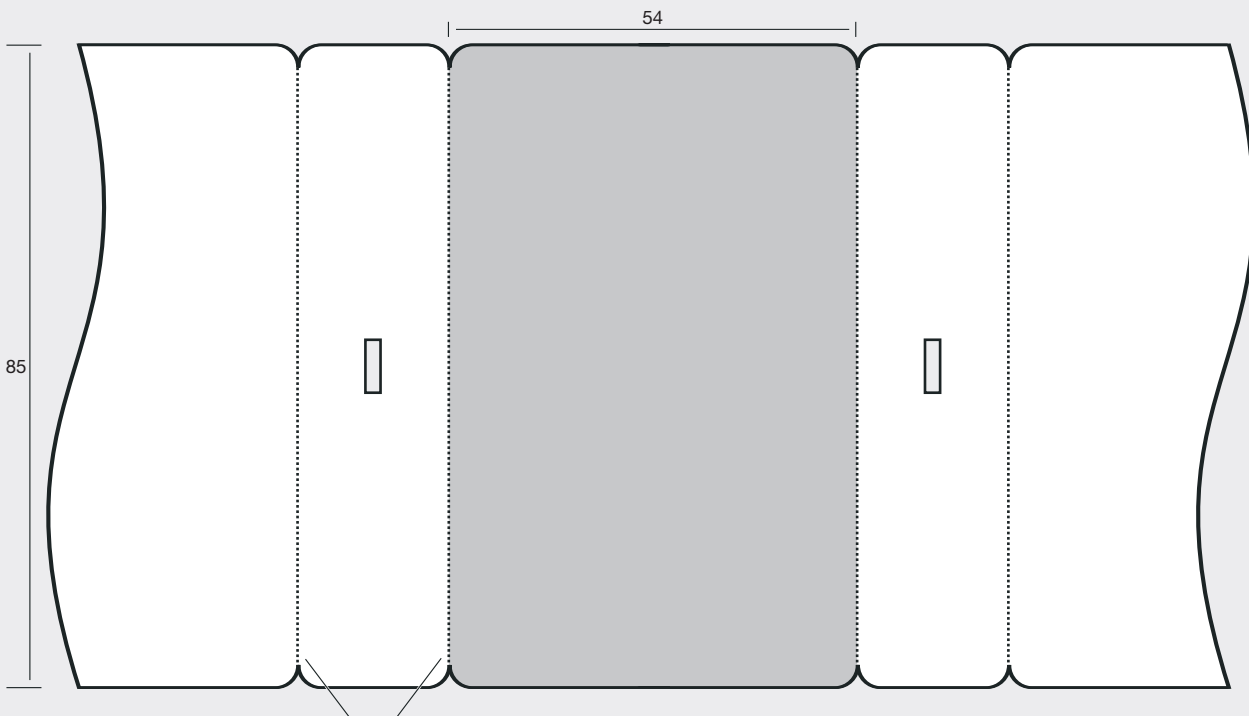

Microperforation an den Trennkanten erlaubt das einfache und saubere Herauslösen der Karten aus der Bahn |

Micro perforation to the separating edges allows the simple and clean extraction of the cards from the label web |

Micro perforation comme arête de coupe permet l'extraction simple et propre des cartes de la bande

Schmuck-Zertifikate im Scheckkarten-Format aus Kunststoff-Materialverbund. Logo farbig vorgedruckt im professionellen Digitaldruck. Für den Eindruck individueller Qualitätsdaten per Thermotransfer-Druck im Etiketten-Drucker |

Jewellery certificates in credit card format made of plastic material composite. Colour logo pre-printed in professional digital printing. For printing individual data of jewellery qualities via thermal transfer printing in the label printer |

Certificats de bijoux au format carte de crédit en plastique composite. Logo en couleur pré-imprimé avec une impression numérique professionnelle. Pour l'impression des données individuelles des bijoux sur une imprimante d'étiquettes à transfert thermique



Etiketten für Uhren

Labels for watches

Étiquettes pour montres

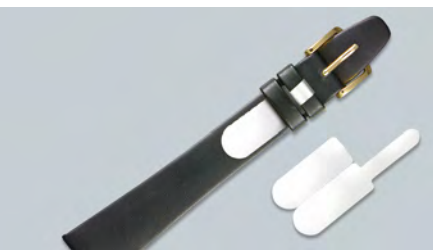

- B** Anzahl Bahnen |
Number of rows |
Nombre de poses
- BB** Bahnbreite |
Width of row |
Largeur de la bande
- T** Etikettenvorschub (Zoll) |
Label feed (inch) |
Avance des étiquettes (pouce)
- *** Mit durchgestanzten Löchern |
With punched holes |
Avec des trous entièrement percés

32 17

B = 2, BB = 60 mm
B = 1, BB = 30 mm

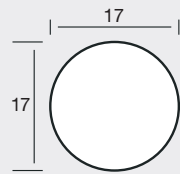

32 17IR

B = 1, BB = 30 mm

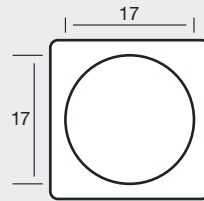

42 27

B = 2, BB = 80 mm, T = 10/8"

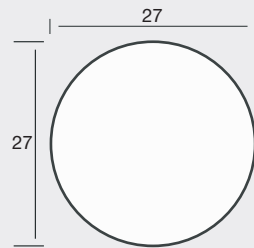

32 30

B = 1, BB = 60 mm

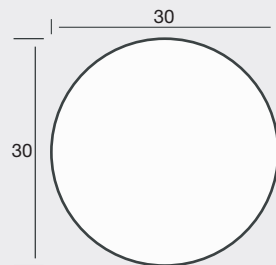

42 35

B = 2, BB = 110 mm, T = 9/6"

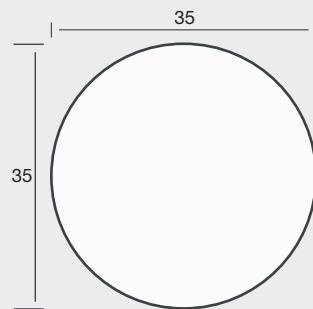

Adhäsions-Etiketten ohne Klebstoff

Adhesive labels without glue
Étiquettes adhésives sans colle

Etiketten aus adhäsivem Material haften durch Oberflächenspannung und lassen sich rückstandslos repositionieren |

Labels of adhesive material stick by surface tension and can be repositioned without residues |

Étiquettes de matériau adhésif collent par la tension de surface et peuvent être repositionnés sans laisser de résidu

Weitere Kreis-Varianten siehe Kapitel „Haftetiketten“ und auf Anfrage |

For more round-shapes please look chapter "Adhesive Labels" and on request |

Plus de variantes de rondes voir chapitre « Étiquettes adhésives » et sur demande



34 1650

B = 1, BB = 88 mm

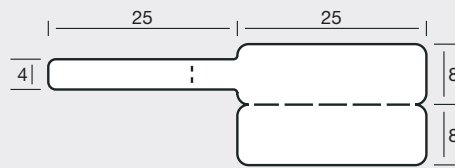

34 2046

B = 2, BB = 120 mm

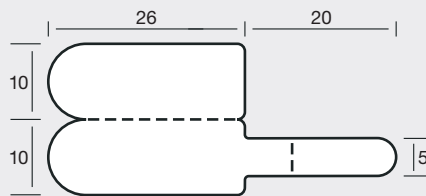

34 2048/2

B = 1, BB = 70 mm

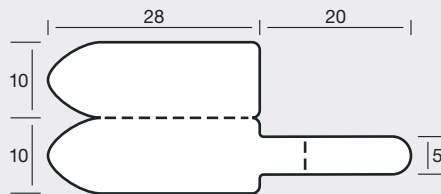

34 2054/3

B = 1, BB = 60 mm

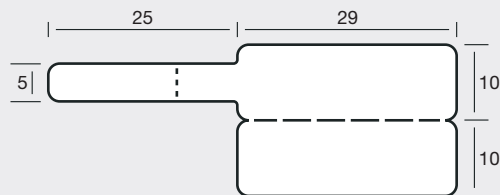

34 2056/1

B = 1, BB = 90 mm

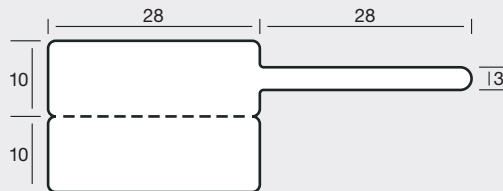

34 2057/2

B = 1, BB = 65 mm

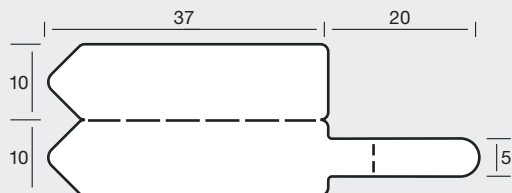

34 2065

B = 1, BB = 70 mm

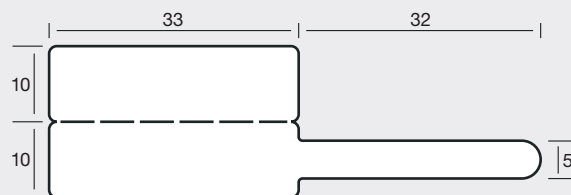

34 2069

B = 1, BB = 80 mm

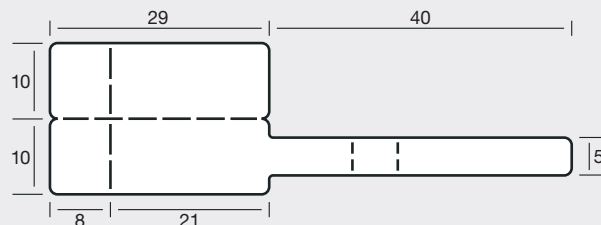

34 2072/4

B = 1, BB = 110 mm

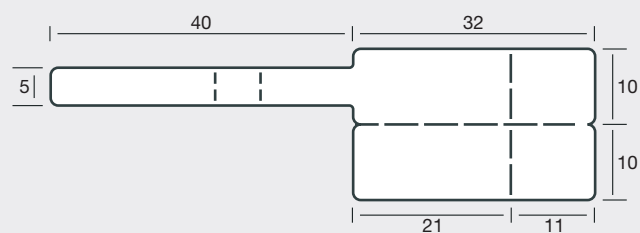

34 2450/2

B = 2, BB = 130 mm

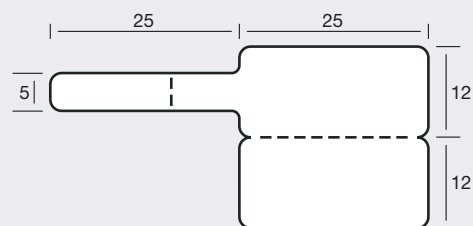

34 2450/4

B = 1, BB = 60 mm

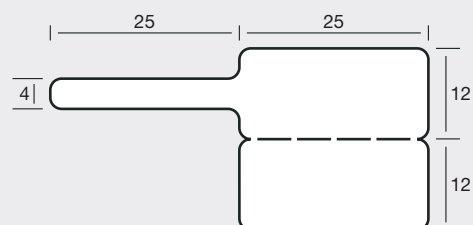

Weitere Schlaufen-Varianten siehe Kapitel „Schlaufen-Etiketten“ und auf Anfrage |

For more shapes with loop please look chapter "Labels with Loop" and on demand |

Plus de variantes avec lanière voir chapitre « Etiquettes avec lanière » et sur demande



35 1755R

B = 1, BB = 70 mm

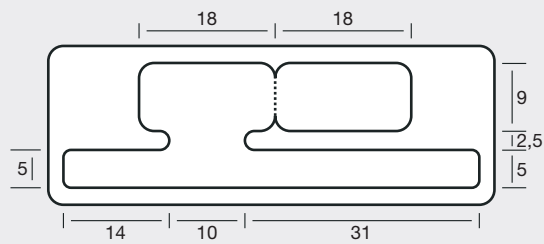

35 2866

B = 1, BB = 69 mm

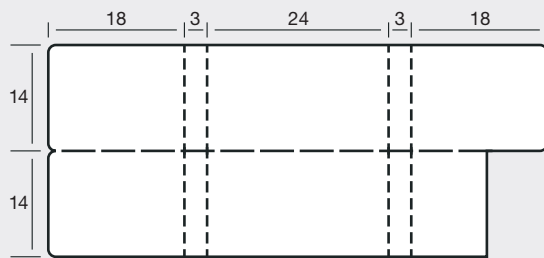

45 4450

B = 2, BB = 130 mm, T = 12/6"

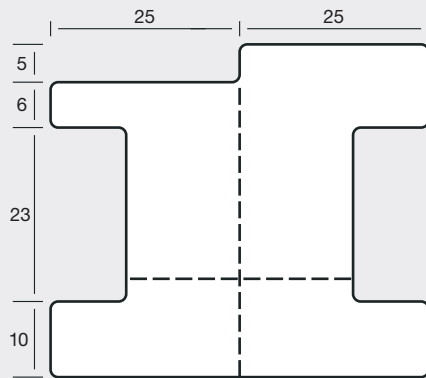

45 6050

B = 2, BB = 60 mm, T = 15/6"

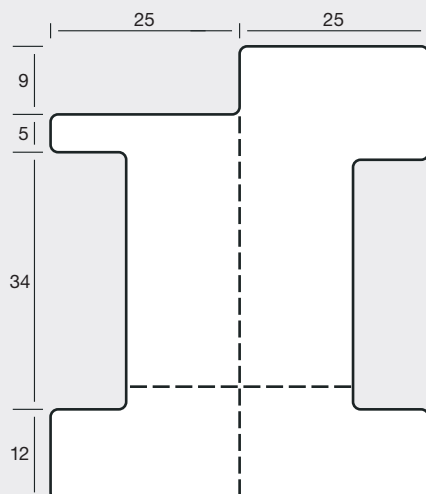

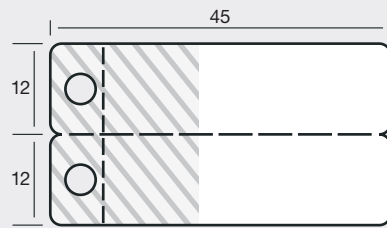

35 2445*

B = 2, BB = 110 mm



Weitere Form-Varianten siehe Kapitel „Schlaufen-Etiketten“ und auf Anfrage |

For more shapes with loop please look chapter "Labels with Loop" and on request |

Plus de variantes avec lanière voir chapitre « Etiquettes avec lanière » et sur demande

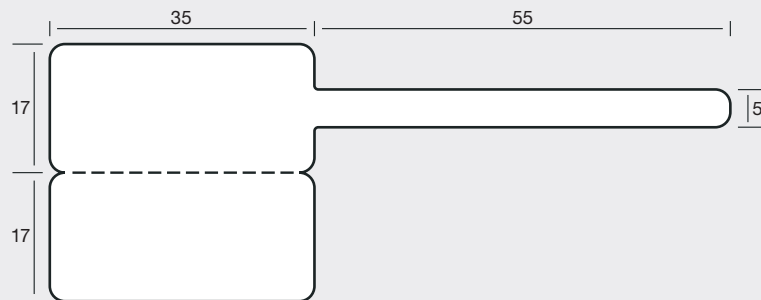

34 3490

B = 1, BB = 120 mm

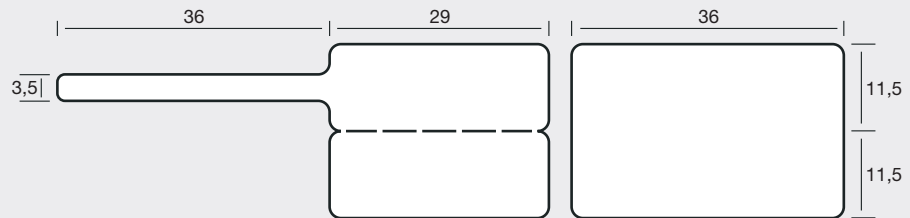

46 23104

B = 1, BB = 108 mm, T = 6/6"

Weitere Kombi-Varianten siehe Kapitel „Kombi- Etiketten“ und auf Anfrage |

For more combined shapes please look chapter "Combinations" and on demand |

Plus de variantes combinaisons voir chapitre « Combinaisons » et sur demande

Brillen-Etiketten

Labels for glasses

Étiquettes pour lunettes



- B** Anzahl Bahnen |
Number of rows |
Nombre de poses
- BB** Bahnbreite |
Width of row |
Largeur de la bande
- T** Etikettenvorschub (Zoll) |
Label feed (inch) |
Avance des étiquettes (pouce)
- *** Mit durchgestanzten Löchern |
With punched holes |
Avec des trous entièrement percés

31 340IR

B = 1, BB = 60 mm

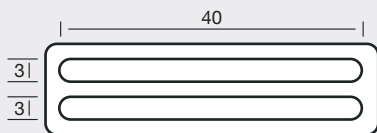

41 540

B = 2, BB = 106 mm, T = 2/6"

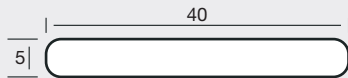

41 545/1

B = 2, BB = 120 mm, T = 2/6"

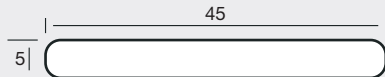

38 855

B = 1, BB = 60 mm

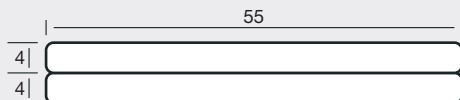

48 1040

B = 1, BB = 60 mm, T = 3/6"

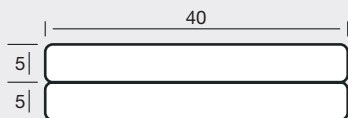

Weitere Rechteck-Varianten siehe Kapitel „Haftetiketten“ |

For more rectangle-shapes please look chapter "Adhesive Labels" |

Plus de variantes de rectangle voir chapitre « Etiquettes adhésives »

31 716

B = 3, BB = 70 mm

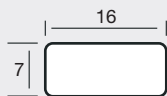

41 820

B = 4, BB = 120 mm, T = 3/6"

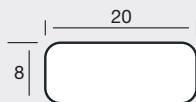

41 1020

B = 5, BB = 135 mm, T = 3/6"

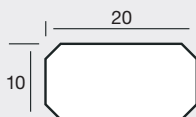

41 1020/4

B = 3, BB = 80 mm, T = 3/6"

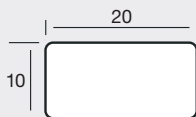

41 1022/3

B = 2, BB = 80 mm, T = 3/6"



41 1025

B = 3, BB = 106 mm, T = 3/6"

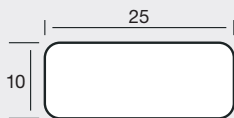

41 1030/2

B = 3, BB = 130 mm, T = 3/6"

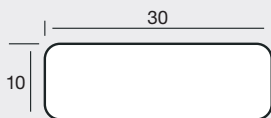

Adhäsions-Etiketten ohne Klebstoff Adhesive labels without glue Etiquettes adhésives sans colle

Etiketten aus adhäsivem Material haften durch Oberflächenspannung und lassen sich rückstandslos repositionieren |

Labels of adhesive material stick by surface tension and can be repositioned without residues |

Étiquettes de matériau adhésif collent par la tension de surface et peuvent être repositionnés sans laisser de résidu



34 869IR

B = 1, BB = 85 mm

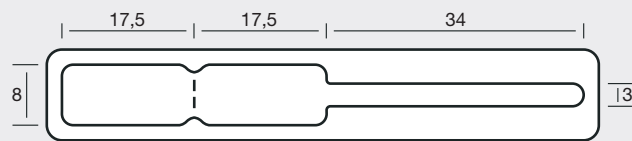

44 1072

B = 1, BB = 88 mm, T = 3/6"



44 1390

B = 1, BB = 110 mm, T = 4/6"

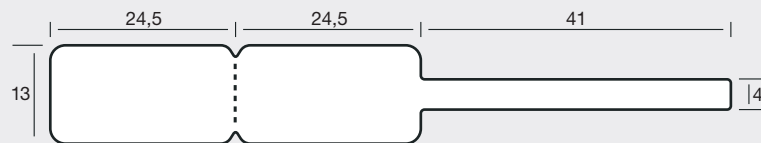

34 1852IR

B = 1, BB = 85 mm

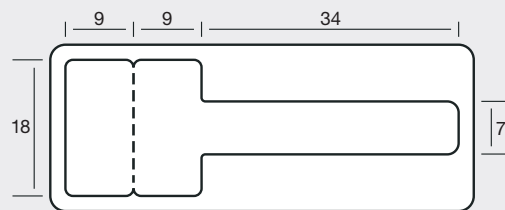

34 1947IR

B = 1, BB = 88 mm

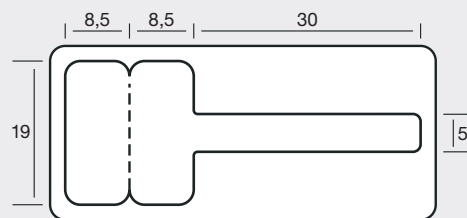

34 2250IR

B = 1, BB = 88 mm

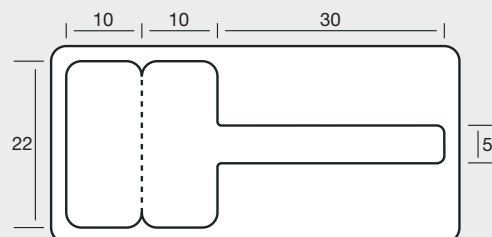

34 2270IR

B = 1, BB = 80 mm

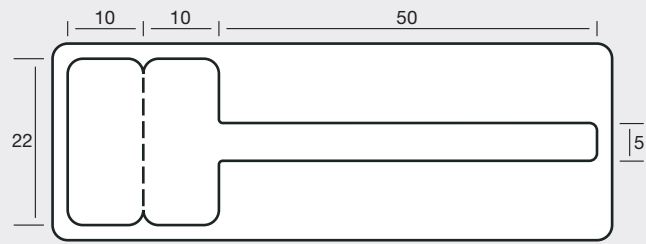

34 3050IR

B = 1, BB = 88 mm

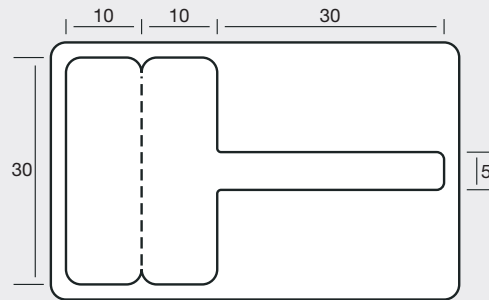

34 5022IR

B = 1, BB = 40 mm

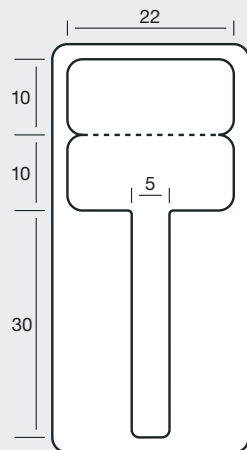

Weitere Schlaufen-Varianten siehe Kapitel „Schlaufen-Etiketten“ und auf Anfrage |

For more shapes with loop please look chapter "Labels with Loop" and on demand |

Plus de variantes avec lanière voir chapitre « Etiquettes avec lanière » et sur demande

37 5485S*

B = 1, BB = 85 mm

Scheckkartenformat |
credit card size |
format carte de crédit

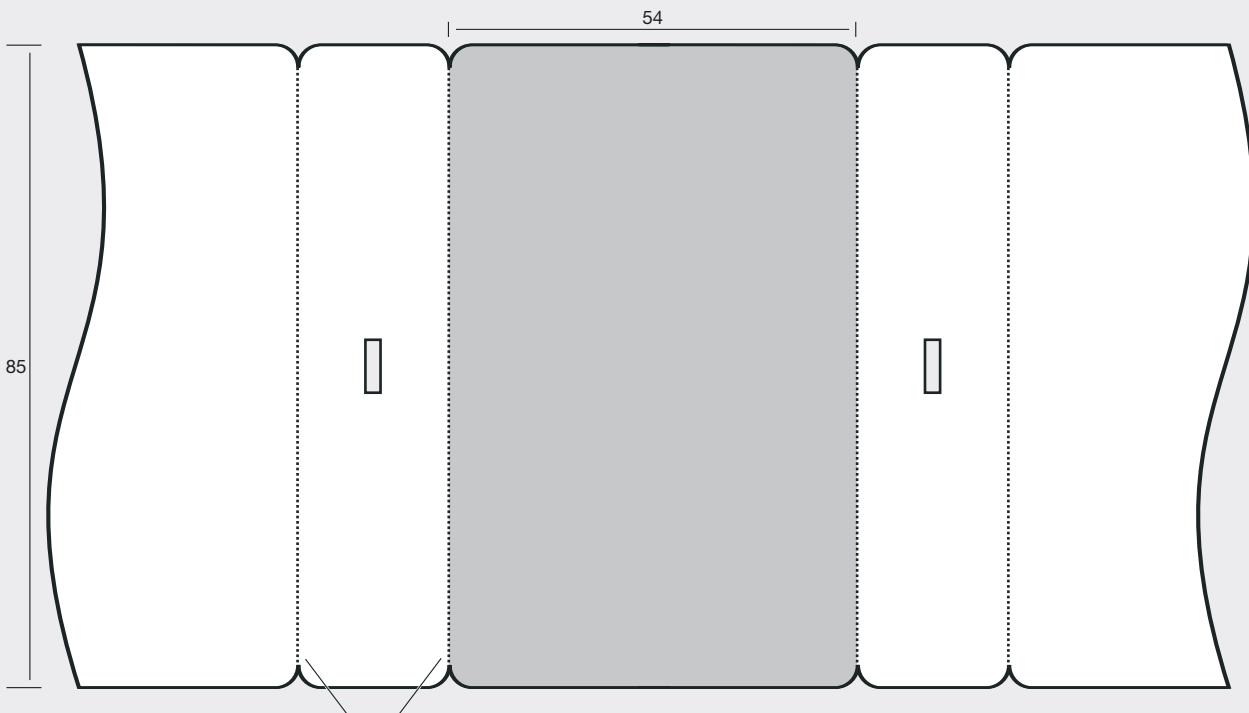

Microperforation an den Trennkanten erlaubt das einfache und saubere Herauslösen der Karten aus der Bahn |

Micro perforation to the separating edges allows the simple and clean extraction of the cards from the label web |

Micro perforation comme arête de coupe permet l'extraction simple et propre des cartes de la bande

Brillen-Pässe im Scheckkarten-Format aus Kunststoff-Materialverbund. Logo farbig vorgedruckt im professionellen Digitaldruck. Für den Eindruck individueller Brillen-Daten per Thermotransfer-Druck im Etiketten-Drucker |

Eyeglass descriptions in credit card format made of plastic material composite. Colour logo pre-printed in professional digital printing. For writing individual eyewear data via thermal transfer printing in the label printer |

Carte de données optiques personnelles au format carte de crédit en plastique composite. Logo en couleur pré-imprimé avec une impression numérique professionnelle. Pour l'impression des données individuelles des lunettes sur une imprimante d'étiquettes à transfert thermique



Brillenbügel-Reiter | Flags for temple arms |
Onglets pour branches de lunettes

Zum Aufschieben auf den Brillenbügel, als Träger für selbstklebende
Etiketten aus dem Thermotransfer-Drucker oder direkt beschrifteten
von Hand mit Permanentmarker |

For sliding onto the temple arms, as a carrier for self-adhesive labels
printed by the thermal transfer printer or to be written on by hand
directly with permanent marker |

Pour glisser sur la branche comme porte-étiquette pour les ad-
hésives de l'imprimante transfert thermique ou bien des ceux-ci
directement écrits manuellement avec des marqueurs permanents



73 1846

B = 1, BB = 60 mm

Haftetiketten Rechteckige, runde und ovale Formen

Adhesive labels

Rectangular, round and oval shapes

Étiquettes adhésives

Rectangulaires, rondes et des formes ovales

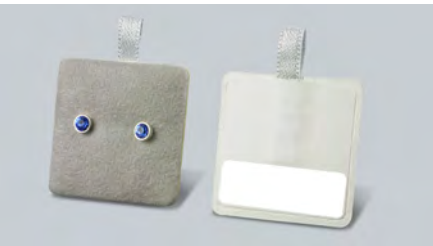

- B** Anzahl Bahnen |
Number of rows |
Nombre de poses
- BB** Bahnbreite |
Width of row |
Largeur de la bande
- T** Etikettenvorschub (Zoll) |
Label feed (inch) |
Avance des étiquettes (pouce)

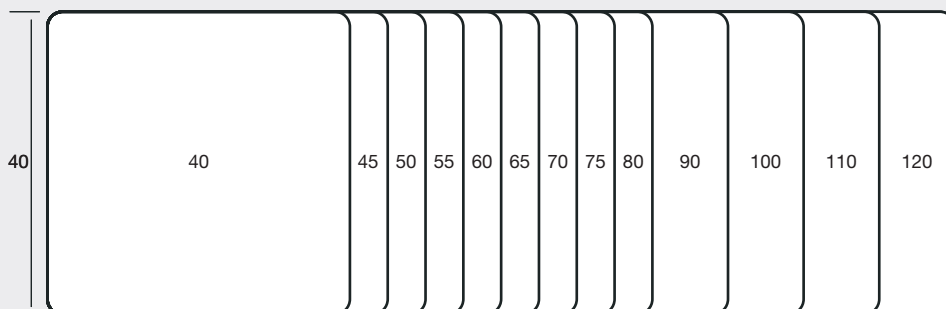
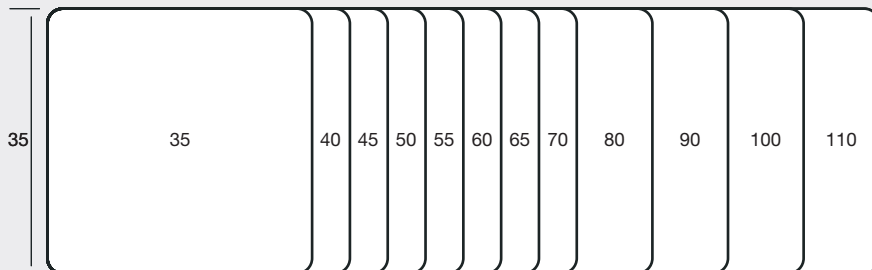
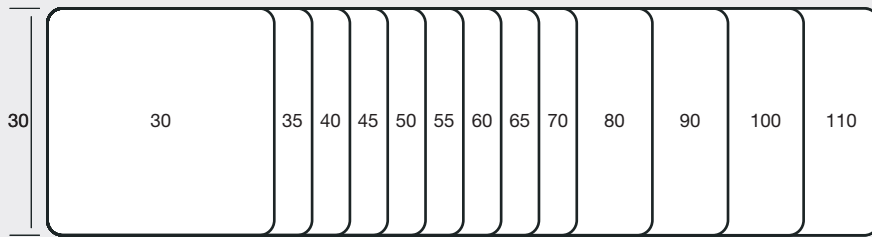
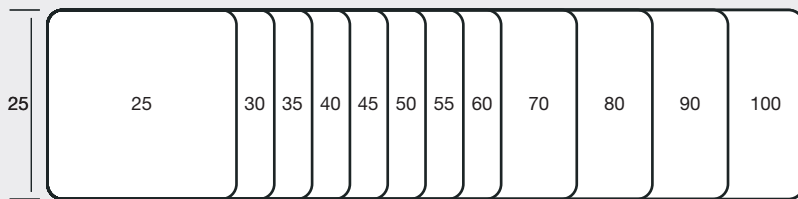
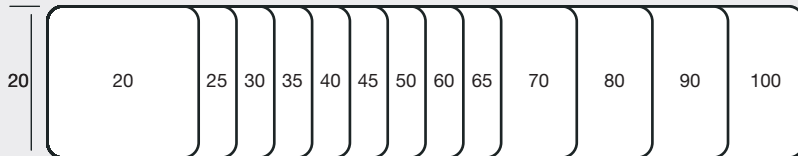
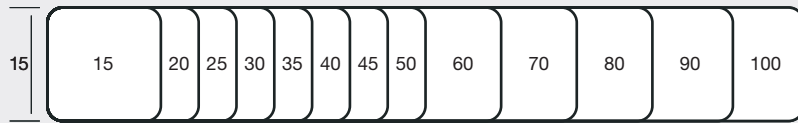
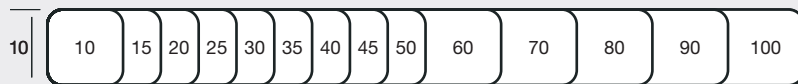

Standard-Formen, Maße in Millimeter, verfügbar auch mit spitzen Ecken |

Standard shapes, dimensions in millimeters, available also with pointed corners |

Formes standard, dimensions en millimètres, également disponible avec des coins pointus

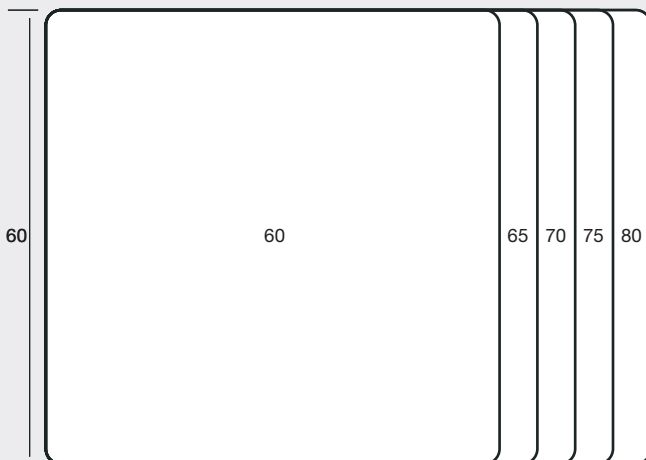
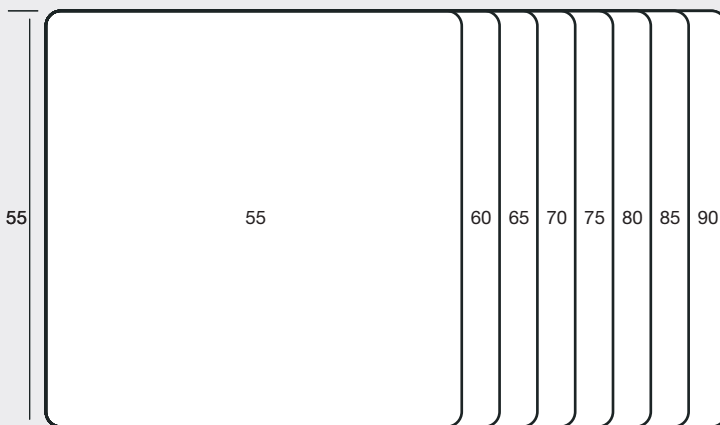
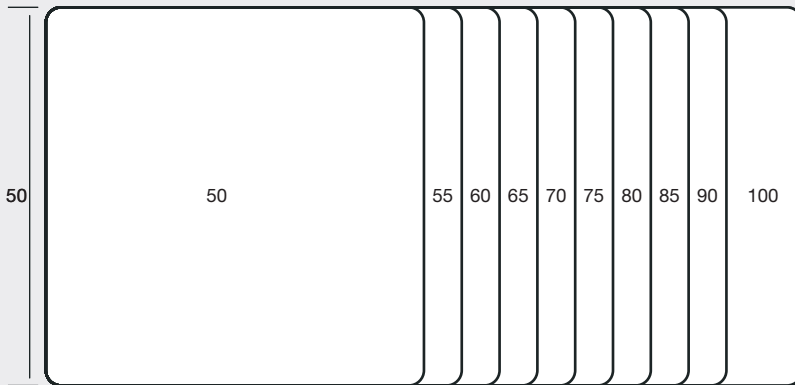
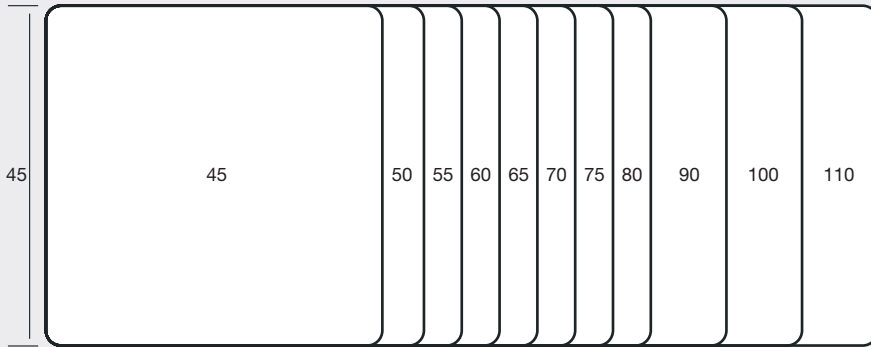

Standard-Formen, Maße in Millimeter, verfügbar auch mit spitzen Ecken |

Standard shapes, dimensions in millimeters, available also with pointed corners |

Formes standard, dimensions en millimètres, également disponible avec des coins pointus

31 340IR

B = 1, BB = 60 mm

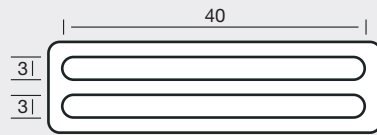

41 540

B = 2, BB = 106 mm, T = 2/6"

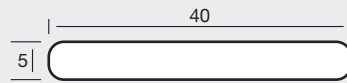

41 545/1

B = 2, BB = 120 mm, T = 2/6"

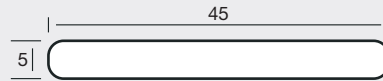

38 855

B = 1, BB = 60 mm

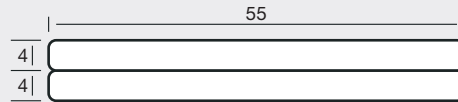

48 1040

B = 1, BB = 60 mm, T = 3/6"

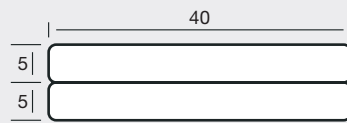

31 716

B = 3, BB = 60 mm



41 1020

B = 5, BB = 135 mm, T = 3/6"

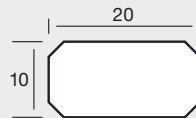

41 1022/3

B = 2, BB = 80 mm, T = 3/6"

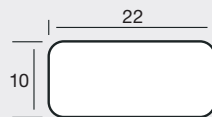

41 1044LP

B = 1, BB = 60 mm, T = 3/6"

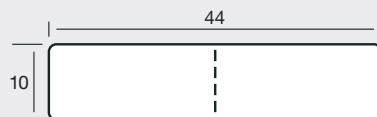

41 1218

B = 5, BB = 120 mm, T = 5/8"

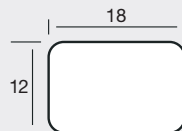

31 1225

B = 1, BB = 40 mm

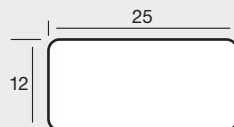

31 1930/1

B = 1, BB = 40 mm
B = 2, BB = 80 mm

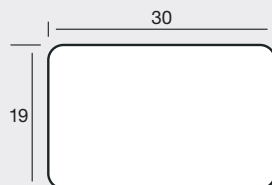

41 2019

B = 3, BB = 90 mm, T = 6/6"

Geeignet für
Träger-Etikett
73 377/2G

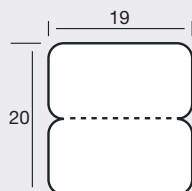

41 2022/3QP

B = 1, BB = 40 mm, T = 6/6"

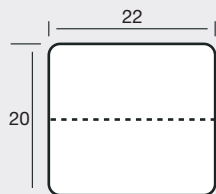

31 2030/1QP

B = 1, BB = 40 mm

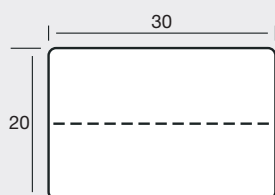

31 2533QP

B = 2, BB = 90 mm
für KAUFHOF

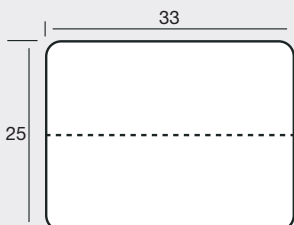

31 2848/1

B = 1, BB = 51 mm

Geeignet für Edelstein-
Klarsicht-Dosen |
Suitable for transparent
gem boxes |
Convient pour boîte
transparente pour les
pierres précieuses

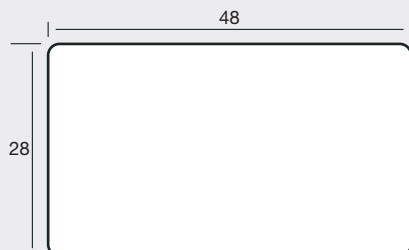

41 3232

B = 1, BB = 60 mm, T = 9/6"
passend für Samtkarten |
for velvet-covered cards |
convient aux cartes en
velour (Kling-Nr. 828/628)

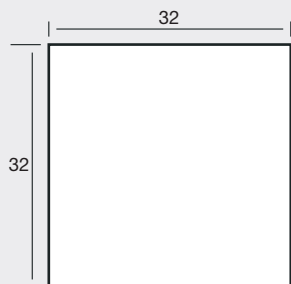

41 3422/1QP

B = 1, BB = 60 mm, T = 9/6"
(Einklebeetikett für
Anhängbüchlein
Ref.Nr. 14 2736)

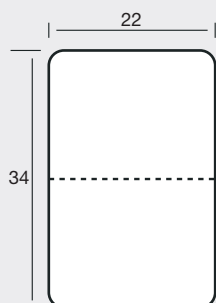

31 2426QP

B = 2, BB = 80 mm

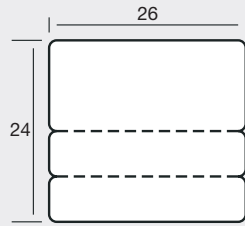

31 3024LP

B = 1, BB = 80 mm

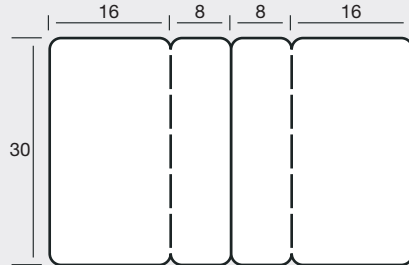

41 3230QP

B = 2, BB = 100 mm, T = 9/6"

Abriss-Etikett für
Kartuschen |
Tear-off label for
cartridges |
Étiquette déchirable
pour cartouches

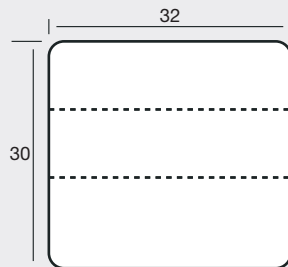

31 3323QP

B = 2, BB = 80 mm

Abriss-Etikett für
Kartuschen |
Tear-off label for
cartridges |
Étiquette déchirable
pour cartouches

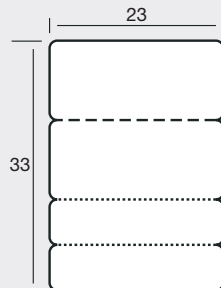

41 3630/2QP

B = 2, BB = 80 mm, T = 9/6"

Abriss-Etikett für
Kartuschen |
Tear-off label for
cartridges |
Étiquette déchirable
pour cartouches

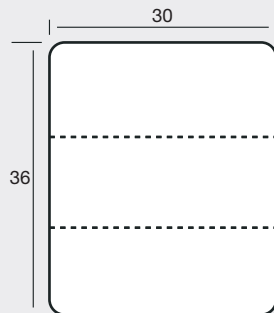

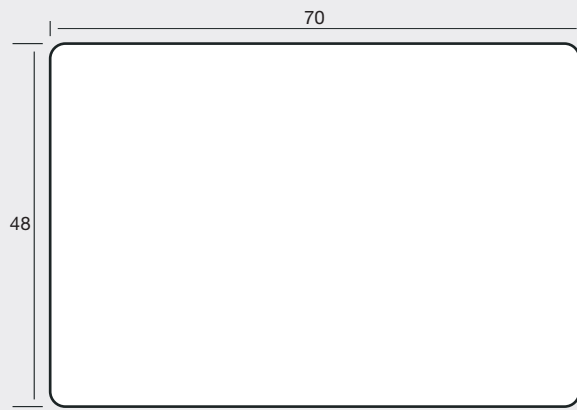

41 4870

B = 1, BB = 80 mm, T = 12/6"

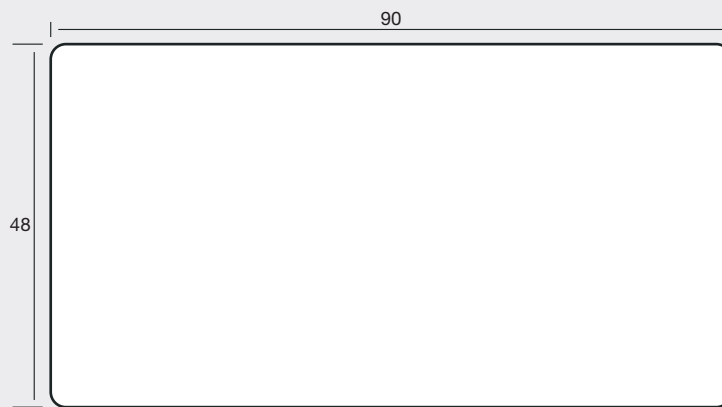

41 4890

B = 1, BB = 100 mm, T = 12/6"

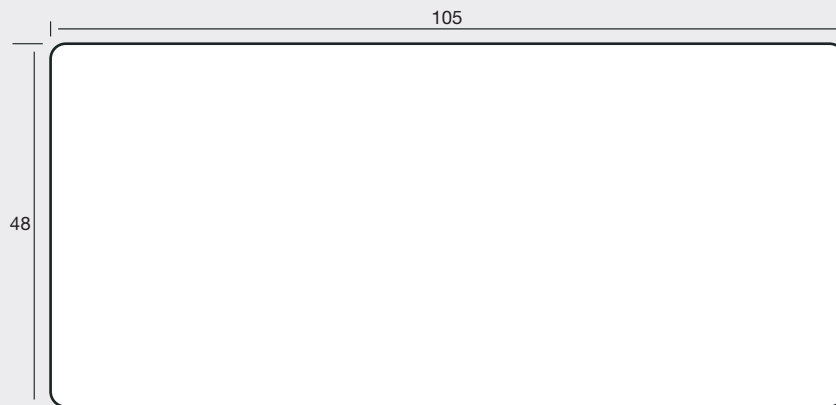

41 48105

B = 2, BB = 108 mm, T = 12/6"

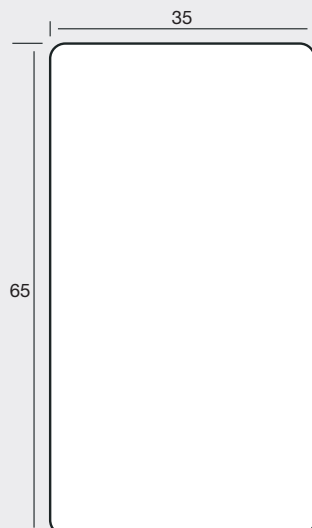

41 6535/1

B = 1, BB = 70 mm, T = 18/6"
Rezept-Etikett für Optiker

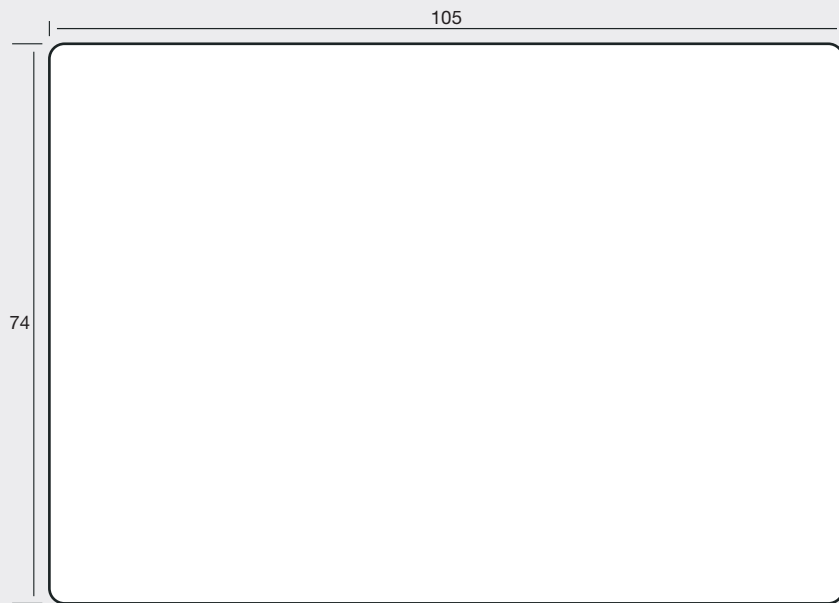

41 74105

B = 2, BB = 110 mm, T = 18/6"



41 125101

B = 2, BB = 110 mm, T = 30/6"



41 148105

B = 1, BB = 110 mm, T = 36/6"

Bitte beachten Sie:

Hunderte weiterer Rechteck-Varianten auf Anfrage |

Attention: Hundreds of other rectangular-shapes on request |

Attention: Des centaines d'étiquettes rectangulaires différentes sur demande

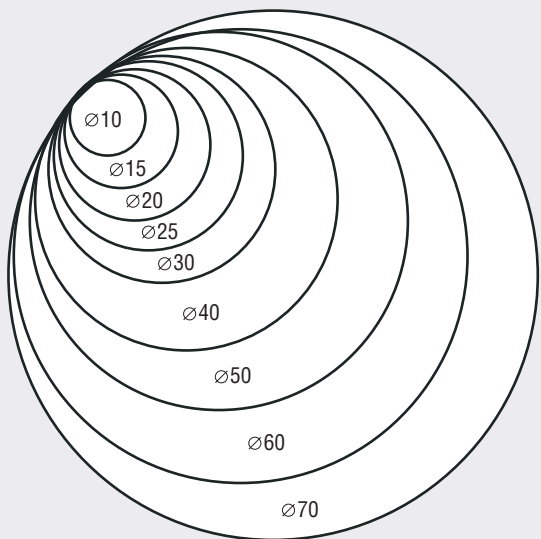

20 x 20 mm

25 x 15 mm

30 x 20 mm

40 x 25 mm

45 x 30 mm

50 x 35 mm

60 x 40 mm

70 x 45 mm

80 x 50 mm

90 x 55 mm

32 17

B = 2, BB = 60 mm
B = 1, BB = 30 mm

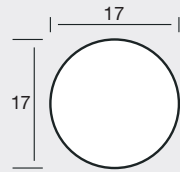

32 17IR

B = 1, BB = 30 mm

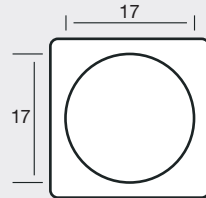

33 2545IR

B = 1, BB = 60 mm

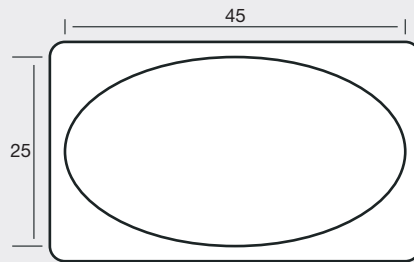

42 27

B = 2, BB = 80 mm

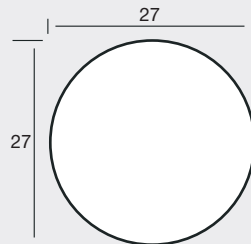

32 30

B = 1, BB = 60 mm

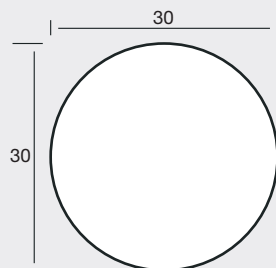

42 35

B = 2, BB = 110 mm

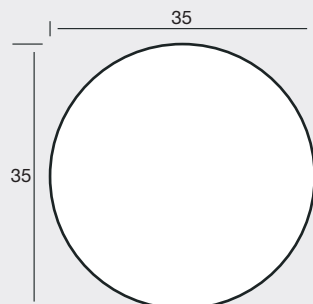

Bitte beachten Sie:

Hunderte weiterer Kreis- und Oval-Varianten auf Anfrage |

Attention: Hundreds of other round and oval shapes on request |

Attention: Des centaines d'étiquettes rondes et des formes ovales différentes sur demande

35 1930/1

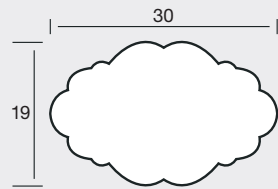

35 2332/1

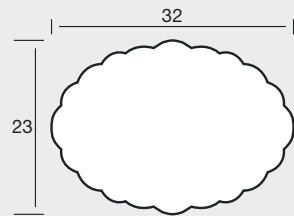

35 2842/3

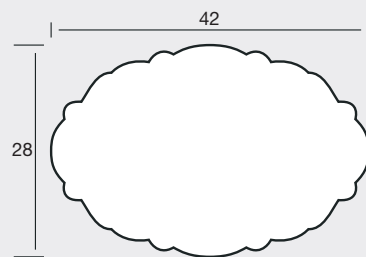

Geschäftszeiten |
Business hours |
Heures d'ouverture

*Montag – Donnerstag
8.00 – 16.30 Uhr
und Freitag 8.00 – 12.00 Uhr*

*Monday – Thursday
8.00h – 16.30h
and Friday 8.00h – 12.00h*

*Lundi – Jeudi
8.00h – 16.30h
et Vendredi 8.00h – 12.00h*



Ferdinand Eisele GmbH

Carl-Benz-Str. 17 | 75217 Birkenfeld/Germany
Tel. +49 7231 9479-0 | info@extra4.com
www.extra4.com

